

Los mejores productos para **promocionar tu marca**

06

GREEN IDEAS

78

TECHNOLOGY

114

WRITING & OFFICE

144

BAGS & TRAVEL

194

WINTER &
RAINY DAYS

204

EATING &
DRINKWARE

238

HOME, GIFT
& PREMIUM

262

TOOLS &
PETS CARE

274

SUBLIMATION

282

PARTY & EVENTS

296

SUMMER

310

LEISURE & SPORT

320

PERSONAL
CARE

332

SANITARY & PROTECTION
ANTIBACTERIAL

340

CHRISTMAS

344

INDEX

INDEX

trending

2022



7161 pg. 153



3356 pg. 102



4115 pg. 242





4117 pg. 216



3312 pg. 87



8086 pg. 135

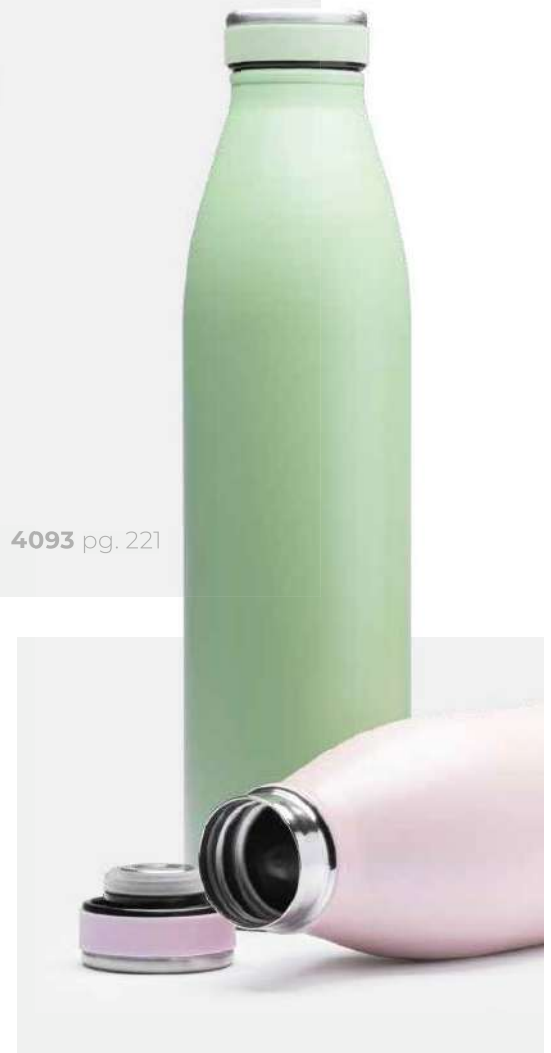

4093 pg. 221



4103 pg. 215

CATALOGUE 2022

Promotional Gifts

Descubre tus productos promocionales en el catálogo **2022**.
Diversas colecciones de artículos que te sorprenderán con productos originales y de diseño, que lograrán que tu marca capte la atención de tus clientes en cualquier ocasión.

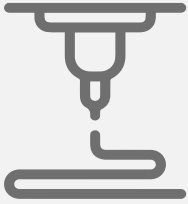

SERVICIO DE IMPRESIÓN

Personaliza cualquiera de nuestros productos con el servicio exclusivo de impresión. Ponemos a tu disposición las técnicas de marcaje más avanzadas del mercado.

CUIDAMOS LA PRESENTACIÓN

Una imagen vale más que mil palabras, por ello cuidamos hasta el más mínimo detalle la presentación de los artículos.



PROMOCIONES RESPONSABLES

Ponemos a tu disposición una gran selección de productos elaborados con materiales naturales y reciclados, para contribuir con la responsabilidad de tener un mundo más sostenible.



YUTE
NATURAL



MADERA
NATURAL



CEMENTO



CORCHO



BAMBÚ



PLA



RABS



RPET



FIBRA DE
TRIGO



FIBRA DE
BAMBÚ



PAPEL
RECICLADO



MATERIAL
ANTIBACTERIAS



ALGODÓN
ORGÁNICO



ALGODÓN
RECICLADO

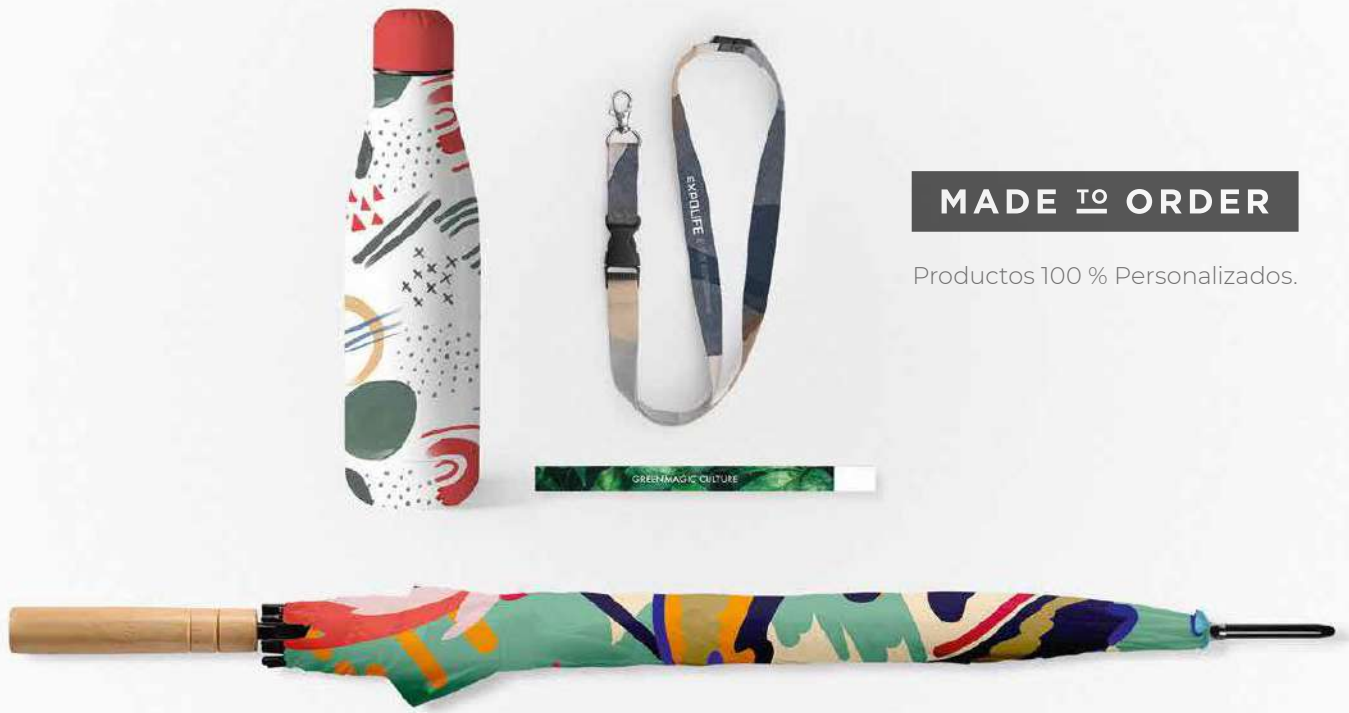

MADE TO ORDER

Productos 100 % Personalizados.



OEKO-TEX STANDARD 100
Este certificado garantiza haber contemplado todos los requisitos medioambientales durante el proceso de fabricación y que los tejidos, sus tintes y cualquier elemento integrante de la prenda, no contiene sustancias nocivas o peligrosas.



SMETA 4 PILLARS
Hemos superado con éxito la auditoría ética Smeta 4 Pillars que garantiza las buenas prácticas de la compañía en los ámbitos de la salud y la prevención de riesgos laborales, los requisitos reglamentarios en materia de trabajo, la seguridad medioambiental, la responsabilidad social corporativa y la ética empresarial.



ISO 14001: 2015
El cumplimiento de esta norma garantiza que la compañía respeta el medio ambiente, ya que ayuda a identificar, priorizar y gestionar los riesgos ambientales.



ISO 9001: 2015
La compañía cumple los requisitos de gestión y aseguramiento de la calidad que certifica esta norma internacional.



ISO 45001: 2018
La compañía cumple con esta norma que establece los requisitos mínimos de las mejores prácticas en gestión de seguridad y salud en el trabajo.



PEFC
Programa que promueve la gestión sostenible de los bosques para conseguir un equilibrio social, económico y medioambiental de los mismos, por lo que el papel de este catálogo, y de la mayoría del material impreso por la compañía, se obtiene de madera de bosques sostenibles.



OSC 100
(Estándar de Contenido Orgánico). Contamos con una gama de productos cuyo tejido es 100 % algodón orgánico certificado. Y que están certificados por Ecocert Greenlife de acuerdo con el estándar disponible en www.ecocert.com con licencia número 198360.



ILO
(Organización Internacional de Trabajo). Todas las fábricas que elaboran nuestros productos cumplen con lo establecido en la Convención de Ginebra n° 138, que regula la edad mínima para emplear menores.



AEO
Authorized Economic Operator. Gorfactory está certificada como una empresa importadora y exportadora de confianza para las autoridades aduaneras en todo el mundo, lo que facilita el tránsito de la mercancía que comercializamos.



Como miembro de Sedex®, Gorfactory asume el código ético de esta organización y cumple todos los requerimientos auditados bajo este estándar social internacional, formando parte de una organización global que promueve la responsabilidad empresarial con la sociedad en su más amplio espectro de actuación. Sedex® ayuda a Gorfactory a gestionar sus actividades sobre derechos laborales, salud y seguridad, entorno, ética empresarial y comercial.



RoHS



+ antibacterial
ISO 22196



**GREEN
IDEAS**





recycledabs



new.



ZIBAL_2999

Cargador inalámbrico con cuerpo en ABS reciclado y superficie superior en tejido RPET. Coloque su smathphone sobre él y déjelo cargar. Compatible con modelos de tecnología inalámbrica 10W. Incluye cable micro USB. Presentación en caja diseño eco.

0,7 x Ø10 cm 50 100

F(1), N(8)

-500	+500	+2000	+5000
9,70 €	9,30 €	8,90 €	8,50 €



new.

newdilbar



new.



CUSTIK_3310

Altavoz inalámbrico con cuerpo tejido en RPET con membrana visible. Bluetooth 5.0. Potencia 3W. Batería recargable. Cable incluido. Presentación en caja diseño eco.

4,6 x Ø7,9 cm 25 50

F(4)

-500	+500	+2000	+5000
14,50 €	13,90 €	13,30 €	12,70 €

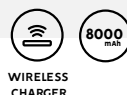

DILBAR_3356

Batería externa de 8000 mAh con cuerpo de ABS reciclado y superficie superior en tejido RPET. Salida de corriente USB DC5V/2.1A. Inalámbrica DC5V. Incluye cable Micro USB. Presentación en caja diseño eco.

7,1 x 1,5 x 13,5 cm 25 50

F(1), N(8)

-500	+500	+2000	+5000
22,30 €	21,30 €	20,30 €	19,30 €



new **valdi**

new.



BAMBOO BLUETOOTH HANDS FREE STEREO SOUND

VALDI_ 3312

Auriculares inalámbricos Bluetooth 5.0 con estuche de carga. Realizados en ABS reciclado y superficie superior de bambú. Panel de control con tecnología táctil integrada en auricular. Función manos libres. Estuche con batería recargable y tapa imantada. Cable Micro USB incluido. Presentación en caja diseño eco.

6,5 x 2,6 x 3,6 cm 1 50

E(4), L2

-500	+500	+2000	+5000
20,30 €	19,20 €	18,40 €	17,60 €



Recycledabs

new.



BLUETOOTH LINE IN

ELSON_ 3311

Altavoz inalámbrico con cuerpo de ABS reciclado. Bluetooth 5.0. Potencia 3W. Batería recargable. Cable incluido. Presentación en caja diseño eco.

6,5 x Ø6,2 cm 25 50

F(4)

-500	+500	+2000	+5000
12,10 €	11,50 €	11,10 €	10,60 €



LUZ LED

new **elson**



corkline

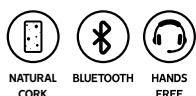

MARCO_ 3211

Altavoz con cuerpo de corcho natural y membrana visible. Bluetooth 5.0. Potencia 3W. Batería recargable. Cable incluido. Presentación en caja diseño eco.

4,6 x Ø7,9 cm 25 50
F(4),L2

-500	+500	+2000	+5000
12,66 €	12,06 €	11,56 €	11,06 €



PROMET_ 3032

Portalápices con cargador inalámbrico integrado. Realizado en corcho natural. Incluye 2 puertos USB adicionales en la parte trasera. 5W. Cable incluido. Presentación en caja diseño eco.

15,2 x 10,6 x 10,6 cm 1 20
F(1),L2

-500	+500	+2000	+5000
19,80 €	19,38 €	18,96 €	18,54 €





wireless chargers



NATURAL CORK WHEAT FIBER WIRELESS CHARGER



SULAC_ 3031

Cargador inalámbrico con cuerpo de corcho natural y fibra de trigo. 5W. Cable incluido. Presentación en caja diseño eco.

1,9 x Ø9 cm 50 100

E(4)

-500	+500	+2000	+5000
8,94 €	8,60 €	8,30 €	7,94 €



NATURAL CORK WIRELESS CHARGER

ALAX_ 3030

Alfombrilla con cargador inalámbrico integrado. Suave superficie plegable de corcho natural con base antideslizante. 5W. Cable incluido. Presentación en caja diseño eco.

26 x 20,3 cm 1 50

F(1),L2

-500	+500	+2000	+5000
12,80 €	12,30 €	11,80 €	11,30 €

HOLDER

CARGADOR INALÁMBRICO



cement&bamboo

MARS3021

HELDENS3209

STEVE3208

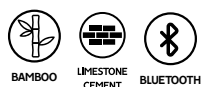

STEVE_3208

Altavoz inalámbrico con cuerpo de cemento piedra caliza y superficie de bambú natural. Bluetooth 5.0. 3W de potencia y batería recargable. Cable incluido. Presentación en caja diseño eco.

7,2 x Ø7 cm 15 30
 F(4), L2

-500	+500	+2000	+5000
18,40 €	17,60 €	16,70 €	15,90 €

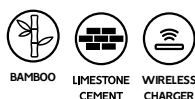

MARS_3021

Cargador inalámbrico con cuerpo de bambú natural y base de cemento piedra caliza. Coloque su Smartphone sobre el y déjelo cargar. Compatible con dispositivos con tecnología inalámbrica. 5W. Cable incluido. Presentación en caja diseño eco.

9,4 x 12,5 x 9,4 cm 15 30
 E(4), L2

-500	+500	+2000	+5000
16,90 €	16,20 €	15,50 €	14,80 €

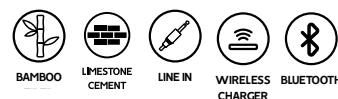

HELDENS_3209

Altavoz Bluetooth con base de carga inalámbrica y membrana visible. Cuerpo de cemento piedra caliza y superficie de bambú natural. 5W de potencia de altavoz y salida inalámbrica de 5W. Batería recargable. Cable incluido. Presentación en caja diseño eco.

11,8 x 7,8 x 6,5 cm 10 20
 F(4), L2

-500	+500	+2000	+5000
23,90 €	22,90 €	21,80 €	21,00 €



fibratrigo



new.

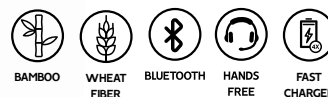

ZATOX_3308

Altavoz bluetooth con base de carga inalámbrica. Cuerpo de fibra de trigo y superficie de bambú natural. 5W de potencia y salida inalámbrica de 10W. Batería recargable. Presentación en caja diseño eco.

16 x 6 x 5,9 cm 15 30

E(4), L2

-500	+500	+2000	+5000
39,40 €	36,24 €	35,94 €	34,20 €

ESTUCHE
DE CARGA



BURAK_3309

Auriculares inalámbricos Bluetooth 5.0 realizados en fibra de trigo con estuche de carga. Panel de control con tecnología táctil, integrado en auricular. Función manos libres. Estuche con batería recargable y tapa imantada. Cable incluido. Presentación en caja diseño eco.

6,8 x 2,2 x 4,5 cm 50 100

E(4), W

-500	+500	+2000	+5000
14,00 €	13,50 €	12,90 €	12,40 €

new
burak

new.



TÁCTIL

estaciones meteorológicas



new.



KELVIN_ 3004

Estación metereológica con carcasa frontal de bambú. Función reloj, calendario y alarma con sensores de temperatura y humedad. Funciona con 2 pilas AAA no incluidas. Presentación en caja diseño eco.

13 x 13 x 2,4 cm 20 40

F(4),L2,W

-500	+500	+2000	+5000
12,90 €	12,40 €	11,90 €	11,40 €



CELSIUS_ 3016

Estación metereológica con carcasa frontal de bambú natural. Función reloj con sensores de temperatura y humedad. Funciona con 2 pilas AAA no incluidas. Presentación en caja diseño eco.

8,6 x 12 x 2 cm 25 50

F(4),L1,W

-500	+500	+2000	+5000
11,56 €	11,06 €	10,60 €	10,20 €

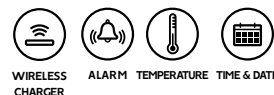

ICARUS_ 3029

Reloj con cargador inalámbrico realizado en madera MDF. Funciones: hora, fecha, alarma y temperatura. 3 modos de iluminación. Cable incluido. Presentación en caja diseño eco.

16 x 2,9 x 7,5 cm 1 50

E(4), L2, W

-500	+500	+2000	+5000
29,80 €	28,80 €	27,80 €	26,30 €

icarus

RELOJ & CARGADOR INALÁMBRICO





ALESSO_ 3210

Altavoz inalámbrico Bluetooth con cuerpo de ABS, frontal de bambú natural y membrana visible. Incluye asa para transporte de polipiel. 3W de potencia. Batería recargable. Cable incluido. Presentación en caja diseño eco.

7,4 x 7 x 4,5 cm 25 50

E(4), L2

-500	+500	+2000	+5000
15,88 €	15,28 €	14,58 €	13,98 €



HARDWELL_ 3207

Altavoz inalámbrico con cuerpo de ABS blanco y bambú natural. Función radio FM, manos libres, ranura para tarjetas mini SD y 3W de potencia. Batería recargable. Cable incluido. Presentación en caja diseño eco.

4,1 x Ø7,3 cm 1 50

F(4), L1

-500	+500	+2000	+5000
10,20 €	9,80 €	9,10 €	8,70 €



LUZ LED

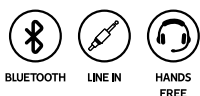

KRAVIZ_ 3206

Altavoz inalámbrico con cuerpo de madera y membrana visible. Ideal para marcaje en láser. Bluetooth 3.0. 3W de potencia. Batería recargable. Cable incluido. Presentación en caja diseño eco.

6 x 6 x 6 cm 1 50

F(4), L1

-500	+500	+2000	+5000
10,90 €	10,50 €	9,80 €	9,50 €



new.



NERVO_ 3306

Altavoz inalámbrico Bluetooth con cuerpo de bambú natural. Función radio FM, manos libres, ranura para tarjeta Micro SD. 3W de potencia. Batería recargable. Cable incluido. Presentación en caja diseño eco.

5,1 x Ø6 cm 25 50

F(4), L1

-500	+500	+2000	+5000
8,96 €	8,60 €	8,20 €	7,80 €



bamboo

wireless chargers

new.



2 SALIDAS USB 3.0



NEBULA_3001

Cargador inalámbrico con cuerpo de bambú natural. Capacidad de carga de hasta 3 dispositivos simultáneamente. Compatible con modelos con tecnología de carga inalámbrica. 10W. Salida corriente USB DC5V/2.1A. Presentación en caja diseño eco.

9 x 0,9 x 9 cm 25 50
E(4),L2,W

-500	+500	+2000	+5000
10,08 €	9,06 €	8,72 €	8,36 €



GRAVITY_3022

Cargador inalámbrico con cuerpo de bambú natural. Coloque su Smartphone sobre el y déjelo cargar. Compatible con dispositivos con tecnología inalámbrica. 5W. Cable incluido. Presentación en caja diseño eco.

7 x 11,5 x 8 cm 25 50
E(4), L2

-500	+500	+2000	+5000
13,72 €	13,22 €	12,52 €	11,92 €

CARGA INALÁMBRICA



CORE_3024

Cargador inalámbrico de bambú natural integrado en bandeja organizadora. Compatible con dispositivos con tecnología de carga inalámbrica. 5W. Cable blanco incluido. Presentación en caja diseño eco.

27 x 1,5 x 14,5 cm 1 20
E(4), L2, W

-500	+500	+2000	+5000
15,48 €	14,78 €	14,08 €	13,38 €

CARGA INALÁMBRICA

new.



BAMBOO WIRELESS CHARGER



BAMBOO

GAMMA_ 3027

Cargador inalámbrico con soporte para móviles y tablets realizado en bambú natural. 5W. Cable de 1m incluido. Presentación en caja diseño eco.

12,5 x 8 x 1,6 cm 50 100

E(4),L2

-500	+500	+2000	+5000
11,60 €	11,10 €	10,70 €	10,30 €

LYRA_ 3010

Soporte de bambú natural para móviles. Ranura inferior para cable de carga. Incluye 2 partes de fácil montaje. Presentación en caja diseño eco.

8 x 8,1 x 12 cm 50 100

D(4), L2, W

-500	+500	+2000	+5000
1,98 €	1,88 €	1,80 €	1,72 €



01

03

60

05

02

226

ÁREA DE IMPRESIÓN



LIGHT

4000 mAh

DROIDE_ 3354

Batería externa solar de 4000 mAh. Indicador de carga LED y luz. Salida de corriente DC5V/2.1A. Incluye cable Micro USB. Presentación en caja diseño.

7,5 x 14,5 x 1,5 cm 20 40

D(2)

-500	+500	+2000	+5000
13,30 €	12,70 €	12,20 €	11,60 €

power bank solar

MOSQUETÓN INCLUIDO

new.



natural bamboo

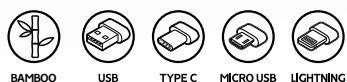

ASTRO_3019

Cable cargador 3 en 1. Cuerpo de ABS y bambú natural. Conexión Micro USB, Tipo C y Lightning. Presentación en bolsa eco con ventana.

16,5 x 1 x 2,1 cm 100 400

D(1), L1

-500	+500	+2000	+5000
3,60 €	3,46 €	3,30 €	3,16 €



ROSSUM_3355

Batería externa de 5000 mAh con cuerpo de ABS blanco y superficie superior de bambú. Salida corriente USB DC5V/2.1A. Incluye cable Micro USB. Presentación en caja diseño eco.

10,1 x 1,5 x 6,3 cm 25 50

E(4), L2, W

-500	+500	+2000	+5000
17,30 €	16,70 €	16,20 €	15,70 €



NEPTUNE_3023

Puerto USB con cuerpo de bambú natural y cable en blanco. Incluye 3 puertos USB. Presentación en caja de diseño eco.

8,5 x 1,6 x 4 cm 50 200

D(4), L1, W

-500	+500	+2000	+5000
6,98 €	6,68 €	6,38 €	6,08 €

BAMBOO

white and wooden



BLUES_3026

Auriculares inalámbricos Bluetooth 5.0 con estuche de carga en bambú natural. Botón multifunción táctil integrado en ambos auriculares. Función manos libres. Batería recargable. Cable incluido. Presentación en caja diseño eco.

7,8 x 3,2 x 3,2 cm

50

100

E(4), L2

-500	+500	+2000	+5000
22,30 €	21,30 €	19,90 €	19,30 €



SOYUZ_3018

Cargador inalámbrico con cuerpo de ABS blanco y superficie superior de bambú natural. Coloque su Smartphone sobre el y déjelo cargar. Compatible con dispositivos con tecnología inalámbrica. DC5V. Cable incluido. Presentación en caja diseño eco.

1 x Ø6 cm

50

200

E(4), L2, W

-500	+500	+2000	+5000
5,70 €	5,40 €	5,20 €	5,00 €



natural bamboo



LÁPIZ

KIOTO_8036

Set de bolígrafo y portaminas en bambú, con mecanismo pulsador y tinta azul. Presentación en caja de cartón efecto madera.

17 x 2,2 x 4,1 cm 20 200
C(4), D(4), L1

-500	+500	+2000	+5000
1,02 €	0,99 €	0,96 €	0,92 €

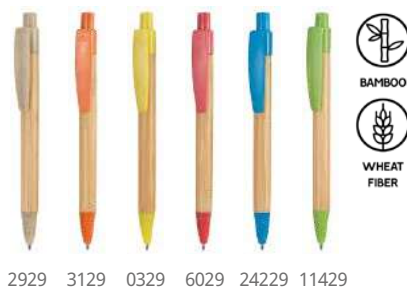

2929 3129 0329 6029 24229 11429

STOA_8034

Bolígrafo pulsador con cuerpo de bambú y accesorios en fibra de trigo / ABS. Tinta azul.

14,1 x Ø1 cm 50 1000
B(4), L1

-500	+500	+2000	+5000
0,270 €	0,260 €	0,250 €	0,240 €

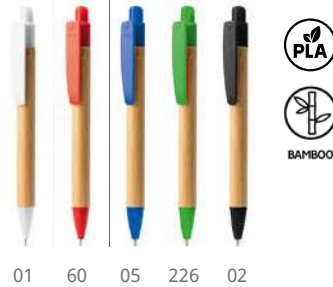

01 60 05 226 02

GILDON_8080

Bolígrafo con cuerpo de bambú y PLA. Tinta azul.

14 x Ø1 cm 50 1000
B(4), L1

-500	+500	+2000	+5000
0,390 €	0,370 €	0,360 €	0,340 €



natural
bamboo

TUCUMA8018



PAMPA8019



NAGOYA8084



BAMBOO



01 60 05 226 02



BAMBOO



TOUCH PEN



29 02 03 60 114 242



BAMBOO



WHEAT FIBER

TUCUMA_ 8018 

Bolígrafo de bambú natural con accesorios de diseño, en acabado plateado y tinta azul.

 13,9 x Ø1,1 cm  50  1000
 B(4), L1

-500	+500	+2000	+5000
0,430 €	0,410 €	0,390 €	0,370 €

PAMPA_ 8019 

Bolígrafo de bambú natural con clip metálico, puntero táctil y carga jumbo de tinta azul.

 14,8 x Ø1 cm  50  1000
 B(4), L1

-500	+500	+2000	+5000
0,500 €	0,480 €	0,470 €	0,450 €

NAGOYA_ 8084 

Bolígrafo pulsador con cuerpo de bambú, accesorios en fibra de trigo y clip metálico. Incluye puntero táctil. Tinta azul.

 14 x Ø1,5 cm  50  1000
 B(4), L1

-500	+500	+2000	+5000
0,430 €	0,420 €	0,400 €	0,390 €

new vernak new.



VERNAK_ 8087

Set de escritura de madera natural presentado en estuche de cartón kraft. Incluye regla, 3 lápices, 1 goma de borrar y 1 sacapuntas.

17,7 x 1,3 x 4,5 cm 20 240

B(4), W

-500	+500	+2000	+5000
0,880 €	0,830 €	0,800 €	0,760 €



36 LÁMINAS

new.



PYRUS_ 8077

Set infantil para colorear. Incluye bloc con dibujos variados. 12 lápices de colores.

10 x 1 x 9,5 cm 50 200

C(4)

-500	+500	+2000	+5000
1,98 €	1,94 €	1,82 €	1,72 €



new.

RESOL_ 8069

Set infantil para colorear. Incluye bloc con dibujos variados, 6 lápices de colores, sacapuntas y goma de borrar. Práctica asa de transporte.

20 x 21 x 1,6 cm 40 80

D(1)

-500	+500	+2000	+5000
2,58 €	2,54 €	2,42 €	2,32 €



20 LÁMINAS

new resol

cartón reciclado

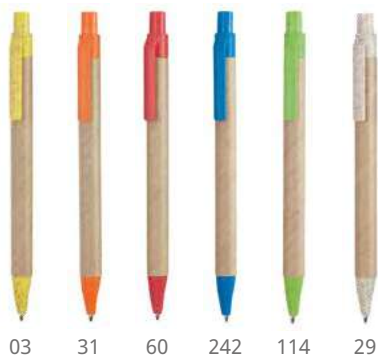

03 31 60 242 114 29

GROVE_ 8029

Bolígrafo pulsador hecho en cartón reciclado, con la punta y el clip en fibra de trigo y ABS. Tinta azul.

14 x Ø1 cm 50 1000

A(4)

-500	+500	+2000	+5000
0,144 €	0,134 €	0,124 €	0,118 €



6029 24229 0229



ALDER_ 8079

Bolígrafo con cuerpo de cartón reciclado y PLA. Tinta azul.

13,9 x Ø0,9 cm 50 1000

A(4), W

-500	+500	+2000	+5000
0,220 €	0,210 €	0,190 €	0,176 €



01 60 05 226 02

LIANDE_ 8042

Bolígrafo de cartón reciclado con capucha. Tinta azul.

14,2 x Ø0,8 cm 50 1000

A(4), W

-500	+500	+2000	+5000
0,210 €	0,200 €	0,190 €	0,180 €



01 03 60 05 226 29



GROVE8029

ALDER8079

LIANDE8042



fibra**trigo**



KAMUT8035



LAURISILVA8026



JADE8027



LIKA8025



29 03 31 60 242 114

WHEAT
FIBER

KAMUT_ 8035

Bolígrafo con pulsador realizado en fibra de trigo y ABS. Tinta azul.

13,8 x Ø1 cm 50 1000
A(4)

-500	+500	+2000	+5000
0,120 €	0,114 €	0,108 €	0,100 €

WHEAT
FIBER

LAURISILVA_ 8026

Bolígrafo con pulsador de fibra de trigo y ABS. Clip ancho especial para marcaje y función soporte. Tinta azul.

15 x Ø1,1 cm 50 1000
A(4)

-500	+500	+2000	+5000
0,330 €	0,300 €	0,260 €	0,230 €

WHEAT
FIBER

JADE_ 8027

Bolígrafo con pulsador de fibra de trigo y ABS. Clip ancho especial para marcaje. Tinta azul.

13,6 x Ø1 cm 50 1000
A(4)

-500	+500	+2000	+5000
0,178 €	0,168 €	0,158 €	0,150 €

TOUCH
PENWHEAT
FIBER

LIKA_ 8025

Bolígrafo giratorio de fibra de trigo y PP con acabados en negro. Tinta azul.

14 x Ø1,3 cm 50 1000
A(4)

-500	+500	+2000	+5000
0,280 €	0,270 €	0,250 €	0,240 €

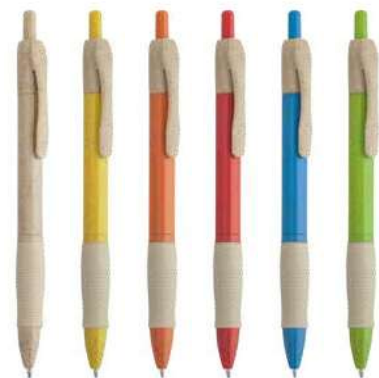

fibra **trigo**

2929 0329 3129 6029 24229 11429



WHEAT
FIBER

HANA_ 8032

Bolígrafo pulsador de fibra de trigo y ABS con cómoda empuñadura. Tinta azul.

 14,5 x Ø1 cm  50  1000

 A(4)

-500	+500	+2000	+5000
0,118 €	0,112 €	0,106 €	0,100 €



29 03 31 60 242 114



WHEAT
FIBER

HAYEDO_ 8030

Bolígrafo pulsador de fibra de trigo y ABS con acabados plateados. Tinta azul.

 14,1 x Ø1 cm  50  1000

 A(4)

-500	+500	+2000	+5000
0,310 €	0,300 €	0,290 €	0,270 €

100% RPET



Hecho a partir de botellas de plástico reciclado

ARASHI8048



00 242

ARAL8037



03 31 49

ARAL8033



00 31 60 242 05 226 02



ARAL_ 8037

Bolígrafo de diseño translúcido realizado a partir de material RPET. Mecanismo pulsador. Tinta azul.

14,1 x Ø1 cm 50 1000
 A(4)

-500	+500	+2000	+5000
0,350 €	0,340 €	0,330 €	0,320 €

ARASHI_ 8048

Bolígrafo marcador 2 en 1 con diseño translúcido, realizado a partir de material RPET. Bolígrafo de tinta azul. Marcador en colores fluor.

14,6 x Ø1,3 cm 50 1000
 A(4)

-500	+500	+2000	+5000
0,530 €	0,520 €	0,510 €	0,500 €

PACIFIC_ 8033

Bolígrafo de diseño translúcido realizado a partir de material RPET. Mecanismo pulsador. Tinta azul.

14,2 x Ø1,1 cm 50 1000
 A(4)

-500	+500	+2000	+5000
0,340 €	0,330 €	0,320 €	0,310 €

100% corcho natural

NATURAL
CORK

ARTUR_ 8044

Elegante bolígrafo metálico con acabado cromado y empuñadura de corcho. Presentación en estuche de corcho. Carga jumbo metálica de tinta azul.

13,9 x Ø1,1 cm 1 200

D(1), L1

-500	+500	+2000	+5000
8,60 €	8,30 €	7,96 €	7,60 €



ARTUR8044



COMPER8043

WHEAT
FIBERNATURAL
CORK

COMPER_ 8043

Bolígrafo línea eco con cuerpo de corcho y detalles en fibra de trigo. Tinta azul.

14 x Ø1 cm 50 1000

A(4)

-500	+500	+2000	+5000
0,260 €	0,250 €	0,240 €	0,230 €



29

60

242

114

02

NATURAL
CORK

VESPULA_ 7546

Estuche de corcho natural con forro interior de poliéster y cremallera.

23 x 11 x 2 cm 50 200

E(1), L2

-500	+500	+2000	+5000
1,75 €	1,68 €	1,61 €	1,54 €



set bambú



BAMBOO

GALA_ 8082

Set libreta y bolígrafo de bambú presentados en estuche eco. Libreta con tapas rígidas, 80 hojas de papel reciclado a una raya. Bolígrafo con detalles cromados y tinta azul.

22 x 24 x 2,2 cm 20 40

E(1), B(1)

-500	+500	+2000	+5000
6,56 €	6,30 €	6,06 €	5,80 €

set corcho



NATURAL CORK

ROBIN_ 8081

Bloc de notas A5 con tapas rígidas de corcho y algodón. 80 hojas lisas. Incluye soporte con bolígrafo de corcho y fibra de trigo a juego. Tinta negra.

15,2 x 21 x 1,4 cm 25 50

E(1), B(1)

-500	+500	+2000	+5000
3,22 €	3,12 €	2,96 €	2,86 €

bloc de notas



IRIS_8071

CALES_8072

ESTELA_8070

NATURAL
CORK

31

60

05

226

02

IRIS_ 8071

Bloc de notas tamaño A6. Tapa rígida en corcho y polipiel. Marcapáginas y banda elástica. 80 hojas.

9,3 x 14,3 x 1,5 cm

50

100

E(4), L2

-500

1,15 €

+500

1,10 €

+2000

1,07 €

+5000

1,03 €

NATURAL
CORK**CALES_ 8072**

Bloc de notas tamaño A6 con tapa rígida de corcho natural. Marcapáginas y banda elástica. 80 hojas.

8,9 x 14 x 1,4 cm

50

100

E(4), L2

-500

0,990 €

+500

0,960 €

+2000

0,930 €

+5000

0,880 €



01

03

60



05

226

02

ESTELA_ 8070

Bloc de notas tamaño A5 con tapa rígida de cartón reciclado. Marcapáginas y banda elástica a color. 100 hojas.

14,7 x 21 x 1,5 cm

25

50

E(4)

-500
1,61 €+500
1,56 €+2000
1,52 €+5000
1,45 €

libretas de cartón



DANICA_ 8053

Libreta tamaño A5 de cartón reciclado. 60 hojas.

14,5 x 21 x 0,8 cm 10 100

E(1)

-500	+500	+2000	+5000
0,560 €	0,550 €	0,540 €	0,530 €



SALER_ 8055

Libreta tamaño A6 de cartón reciclado. 60 hojas.

10,5 x 14,5 x 0,8 cm 20 200

E(1)

-500	+500	+2000	+5000
0,410 €	0,400 €	0,390 €	0,360 €

DANICA8053



SALER8055



31 60 05 226 02

ALANI_ 8073

Libreta con espiral y tapa rígida de cartón reciclado. Bolígrafo a juego con tinta azul incluido. 60 hojas.

16,5 x 21 x 1 cm 20 80

E(4)

-500	+500	+2000	+5000
1,15 €	1,11 €	1,07 €	1,02 €



60 05 226 02

LIEN_ 8074

Libreta con espiral y tapa rígida de cartón reciclado. Bolígrafo a juego con tinta azul incluido. 70 hojas.

9,7 x 14,4 x 1 cm 50 100

D(4), B(4)

-500	+500	+2000	+5000
0,660 €	0,640 €	0,620 €	0,590 €



cubiertas en papel de semillas

Reciclables, degradables y plantables

SAGRA8086

GARO8085



new.



FUNDA PAPEL INCLUIDA

SAGRA_8086

Libreta A6 con cubiertas de papel reciclable y degradable con semillas. 40 hojas papel a una raya. Presentación en funda de papel kraft.

10,7 x 15 x 0,7 cm

100

200

E(1)

-500	+500	+2000	+5000
1,78 €	1,70 €	1,64 €	1,58 €

new.



FUNDA PAPEL INCLUIDA

GARO_8085

Bloc de notas con cubiertas de papel reciclable y degradable con semillas. Incluye 50 hojas de papel reciclado.

7,2 x 10 x 0,8 cm

100

200

D(1)

-500	+500	+2000	+5000
1,56 €	1,50 €	1,44 €	1,38 €

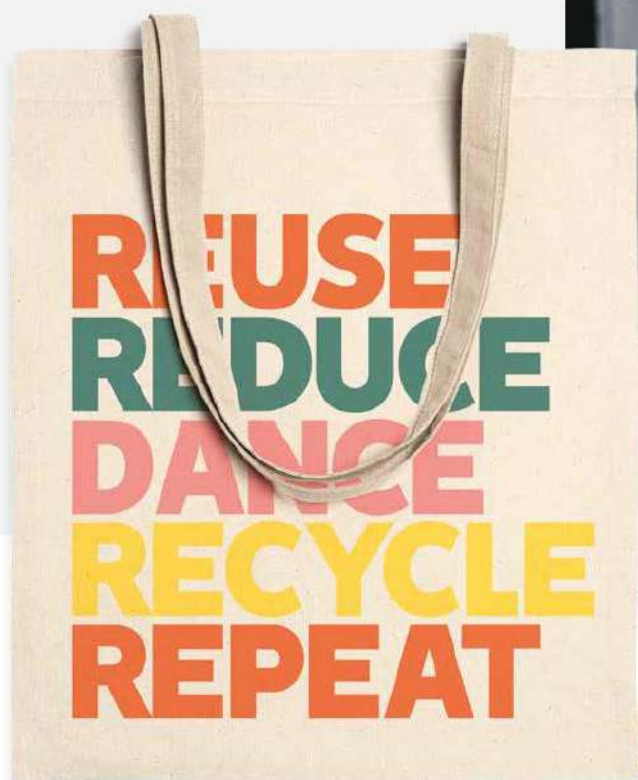

BERNA_ 7156

Bolsa 100% algodón orgánico de 120 g/m² con asas largas reforzadas de 70 cm.

38 x 42 cm 50 200

F(4),N(8),O,P

-500	+500	+2000	+5000
1,83 €	1,76 €	1,69 €	1,62 €

organic cotton

new.



GRETA_ 7167

Bolsa 100% algodón orgánico de 300 g/m² con prácticas asas largas de 70 cm.

40 x 40 cm 10 100

F(4), N(8), P

-500	+500	+2000	+5000
2,92 €	2,84 €	2,77 €	2,70 €

120 g/m²**NARBONA_ 7159**

Bolsa 100% algodón orgánico de 120 g/m² con fuelle y asas cortas reforzadas de 35 cm.

40 x 40 x 10 cm 20 200

F(4), N(8), P

-500	+500	+2000	+5000
2,42 €	2,38 €	2,28 €	2,20 €



organic cotton

new.

280 g/m²**KENSAL_ 7168**

Bolsa 100% algodón orgánico de 280 g/m² con fuelle y prácticas asas largas de 70 cm.

38 x 42 x 9 cm 10 100

F(4), N(8), P, O

-500	+500	+2000	+5000
2,86 €	2,98 €	2,92 €	2,84 €

organiccotton



DELPHIS_7536

Neceser 100% algodón orgánico de 180 g/m² con tirador a juego.

21 x 16 cm 50 300

E(1), N(8), O

-500	+500	+2000	+5000
1,24 €	1,18 €	1,14 €	1,08 €



MUNA_7098

Mochila de cordones 100% de algodón orgánico.

38 x 42 cm 20 100

F(6), N(8), O, P

-500	+500	+2000	+5000
2,06 €	1,98 €	1,90 €	1,88 €



organic cotton



newmauro

new.

 PARTE LISA
PARA MARCAJE
 
**OLIVER_ 9135**

Delantal 100% algodón orgánico con bolsillo frontal.
Talla única ajustable.

 93 x 65 cm
  10
  100

 E(4), N(8), P

-500	+500	+2000	+5000
4,66 €	4,46 €	4,30 €	4,10 €

**MAURO_ 9138**

Manopla 100% de algodón orgánico. Una cara lisa
ideal para marcaje y cinta para colgar.

 30,5 x 19 cm
  25
  200

 E(1), N(8)

-500	+500	+2000	+5000
2,78 €	2,66 €	2,54 €	2,44 €

new.



29 60 05 226 02



BRESCIA_7165

Mochila de cordones en algodón reciclado de 120 g/m² con acabado jaspeado y cordones en color natural.

38 x 42 cm 50 200

F(4), N(8)

-500	+500	+2000	+5000
1,96 €	1,88 €	1,82 €	1,72 €



29 60 05 226 02



VARESE_7107

Bolsa mochila de cordones en algodón reciclado de 140 g/m² con acabado jaspeado con asas largas de 70 cm a juego y cordones en color natural.

38 x 42 cm 20 100

F(6), N(8), O, P

-500	+500	+2000	+5000
2,68 €	2,56 €	2,46 €	2,36 €

recycled
cotton



29 60 05 226 02



RIVOLI_7162

Bolsa realizada en algodón reciclado de 120 g/m² en acabado jaspeado con asas largas de 70 cm.

38 x 42 cm 50 200

F(4), N(8)

-500	+500	+2000	+5000
1,44 €	1,38 €	1,32 €	1,26 €

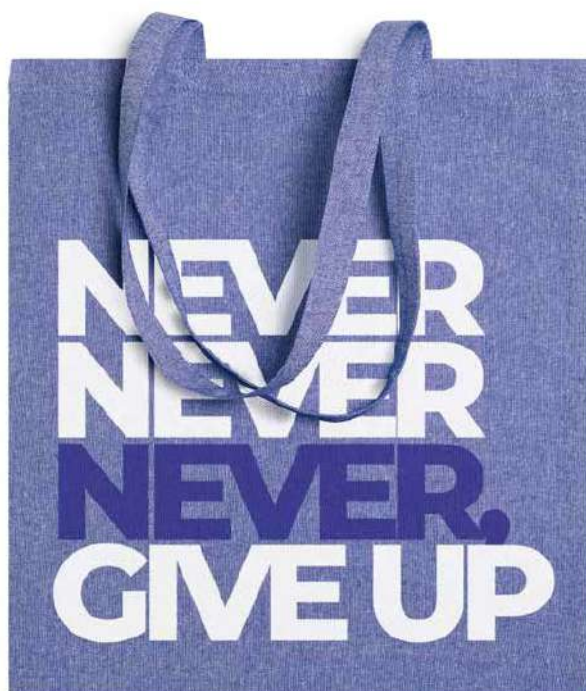

recycled cotton



29

60

05

226

02



AROLA_ 9136

Delantal realizado en algodón reciclado con acabado jaspeado. Bolsillo frontal. Talla única ajustable.

93 x 65 cm

10

100

E(4), N(8), P

-500

+500

+2000

+5000

3,98 €

3,82 €

3,68 €

3,52 €



29

60

05

226

02



REMO_ 7562

Neceser multiusos en algodón reciclado con cremallera y tirador a juego.

21 x 12 x 3 cm

50

300

E(1),N(8),O

-500

+500

+2000

+5000

1,14 €

1,10 €

1,04 €

1,00 €



01 31 60 05 226 02

105 gr/m²

ADARE_ 7175

Mochila 100% de algodón con cordones a juego.

37 x 41 cm 10 100

F(6), N(8), M, O, P

-500	+500	+2000	+5000
1,52 €	1,48 €	1,42 €	1,36 €

new.



100% cotton bags

140 gr/m²

MIRLO_ 7137

Mochila de cordones en 100% algodón de 140 g/m². Cordones de 8 mm. Etiqueta removible.

34 x 42 cm 10 200

F(6), N(8), O, P

-500	+500	+2000	+5000
1,36 €	1,32 €	1,28 €	1,24 €



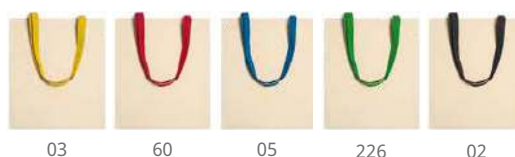
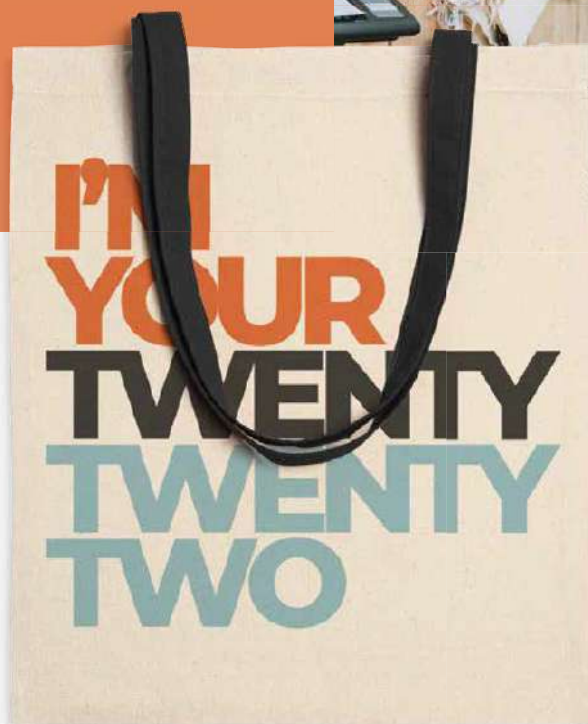

NIZA_7160

105 g/m²

Bolsa 100% de algodón 105 g/m². Asas largas de 70 cm a color.

37 x 41 cm

50

200

F(4), N(8), P

-500	+500	+2000	+5000
1,03 €	0,99 €	0,97 €	0,95 €

HILLOCK_7520

105 g/m²

Bolsa de la compra cosida 100% algodón de 105 g/m², con prácticas asas largas reforzadas de 70 cm.

37 x 41 cm

50

250

F(4), N(8), P

-500	+500	+2000	+5000
0,850 €	0,810 €	0,770 €	0,730 €

HILL_7601

140 g/m²

Bolsa de la compra realizada en 100% algodón de 140 g/m², con asas largas de 70 cm.

37 x 41 cm

20

200

F(4), N(8), P

-500	+500	+2000	+5000
1,06 €	1,03 €	0,99 €	0,95 €

ZENITH_7551

180 g/m²

Bolsa de la compra cosida en 100% algodón de 180 g/m², con prácticas asas largas reforzadas de 70 cm.

41 x 37 cm

50

150

F(4), N(8), P, O

-500	+500	+2000	+5000
1,38 €	1,34 €	1,30 €	1,26 €

100% natural cotton



100% cotton

SOIL_7554
120 g/m²

Bolsa de algodón de 120 g/m² con un lado en diseño liso y otro lado en diseño rejilla. Cierre de cordón ajustable.

25 x 30 cm 50 250

F(4), N(8)

-500	+500	+2000	+5000
1,08 €	1,04 €	1,00 €	0,960 €

ARDEA_7552
105 g/m²

Bolsa estilo saco en algodón de 105 g/m² con auto-cierre de cordones.

15 x 21 cm 50 500

F(4), N(8)

-500	+500	+2000	+5000
0,630 €	0,610 €	0,580 €	0,550 €

LEAF_7553
180 g/m²

Bolsa de la compra realizada en algodón de 180 g/m² con acabado liso y rejilla. Asas reforzadas de 60 cm.

45 x 42 cm 10 100

F(4), N(8)

-500	+500	+2000	+5000
3,30 €	3,16 €	3,00 €	2,90 €



100% cotton

105 g/m²

BAGUETTE_ 7519

Bolsa cosida 100% algodón de 105 g/m², con clásico formato para el pan. Cierre de cordón grueso.

20 x 58 cm 10 500

F(4), N(8)

-500	+500	+2000	+5000
0,810 €	0,780 €	0,760 €	0,730 €

105 g/m²

DUNE_ 7525

Bolsa de la compra plegable 100% algodón de 105 g/m², con asas largas de 70 cm y cordón para plegado ajustable.

37 x 41 cm 10 200

F(4), G(4), N(8)

-500	+500	+2000	+5000
1,61 €	1,53 €	1,47 €	1,39 €



STERNA_ 7555

Bolsa de yute natural laminado con asas en algodón de 70 cm.



44,5 x 35 x 14 cm  5  60

 F(1)

-500	+500	+2000	+5000
3,78 €	3,62 €	3,48 €	3,32 €

KOPER_ 7148

Bolsa de yute natural laminado con ribetes y asas reforzadas de algodón. Acabado cosido

38 x 42 x 16 cm  10  50

 F(1)

-500	+500	+2000	+5000
4,66 €	4,50 €	4,30 €	4,10 €



jute bags

FLAY_ 7164

Bolsa estilo saco de yute natural. Cierre con cordones de algodón.

25 x 32 cm  20  200

 F(1),N(8)

-500	+500	+2000	+5000
1,44 €	1,40 €	1,34 €	1,28 €



PARMA_ 7163

Bolsa estilo saco de yute natural. Cierre con cordones de algodón.

14 x 22 cm  20  400

 F(1),N(8)

-500	+500	+2000	+5000
1,04 €	1,00 €	0,960 €	0,920 €

new.

**GAVIA_ 7099**

Bolsa de yute laminado con bolsillo frontal y asas largas en algodón natural.

48 x 15 x 35 cm 10 80

F(1)

-500	+500	+2000	+5000
3,76 €	3,60 €	3,40 €	3,30 €



03 31 60 05 226 02 40

NIMES_ 7149

Bolsa de yute natural con asas reforzadas de algodón a color. Acabado cosido.

38 x 41 cm 10 80

F(1)

-500	+500	+2000	+5000
2,50 €	2,40 €	2,30 €	2,20 €

new.



NANTES_ 7110

Bolsa de yute laminado con una cara de algodón ideal para marcaje y asas largas.

40 x 16 x 32 cm 10 50

F(4)

-500	+500	+2000	+5000
3,90 €	3,70 €	3,54 €	3,38 €



29 60 05 226

new
nantes

INTERIOR ISOTÉRMICO



VENICE_ 7161

Bolsa nevera de yute laminado. Interior isotérmico de aluminio con cierre de velcro. Bolsillo frontal y asas en algodón natural.

43 x 20 x 34 cm 10 40

F(1)

-500	+500	+2000	+5000
7,90 €	7,70 €	7,46 €	7,20 €

new.



new **venice**

**WILKES_ 7557**

Mochila de cordones realizada en algodón de 120 g/m² y yute.

34 x 43 cm 10 100

F(6), N(8), O, P

-500	+500	+2000	+5000
1,98 €	1,88 €	1,80 €	1,68 €



cotton & jute

**WAVE_ 7556**

Bolsa de la compra realizada en algodón de 120 g/m² y yute, con prácticas asas reforzadas de 70 cm.

37 x 41 cm 10 200

F(6), N(8), P

-500	+500	+2000	+5000
1,70 €	1,63 €	1,56 €	1,49 €

new.



new.



VERA_ 7563

Necesar realizado en algodón y yute laminado. Cremallera con tirador de yute a juego.

20 x 15 x 6 cm 50 200

E(1), N(8)

-500	+500	+2000	+5000
2,08 €	2,02 €	1,90 €	1,82 €



SIENA_ 7564

Necesar realizado en algodón y yute laminado. Cremallera con tirador de yute a juego.

21 x 11 x 6 cm 50 200

E(1), N(8)

-500	+500	+2000	+5000
2,30 €	2,20 €	2,10 €	1,98 €

**jute &
cotton**



jute & cotton

SIERRA_7558

Neceser multiusos realizado en algodón de 180 g/m² y yute. Cremallera con tirador de yute a juego.

21,5 x 16 x 5 cm 10 200

E(1), N(8)

-500	+500	+2000	+5000
1,50 €	1,44 €	1,39 €	1,35 €



TYTO_7560

Neceser de yute natural con cremallera a juego. Tirador de yute.

22 x 14 x 6,5 cm 10 200

E(1)

-500	+500	+2000	+5000
1,01 €	0,970 €	0,940 €	0,900 €

beauty
bags

takeaway

OLMO_ 7122

Bolsa de papel de 80 g/m² en acabado natural. Asas cortas reforzadas de diseño plano. Ideal para hostelería y restauración (take away).

30 x 29 x 20 cm  200

 F(1)

-500	+500	+2000	+5000
0,330 €	0,320 €	0,310 €	0,300 €



paper bags



PINUS_ 7123

Bolsa de papel de 100 g/m² en acabado natural. Asas cortas reforzadas de diseño rizado. Ideal para botellas.

12 x 36 x 10 cm  100  400

 F(1)

-500	+500	+2000	+5000
0,350 €	0,340 €	0,330 €	0,320 €



29 01 60 55 02

MAPLE_7541

Bolsa de papel de 110 g/m². Asas cortas reforzadas de diseño rizado.

41 x 32 x 12 cm 200

F(1)

	-500	+500	+2000	+5000
Color 29	0,350 €	0,340 €	0,330 €	0,320 €
	0,420 €	0,410 €	0,400 €	0,390 €



29 01 60 55 02

ROBLE_7540

Bolsa de papel de 110 g/m². Asas cortas reforzadas de diseño rizado.

32 x 40 x 12 cm 200

F(1)

	-500	+500	+2000	+5000
Color 29	0,350 €	0,340 €	0,330 €	0,320 €
	0,420 €	0,410 €	0,400 €	0,390 €



29 01 60 55 56 02

HAYA_7539

Bolsa de papel de 110 g/m². Asas cortas reforzadas de diseño rizado.

22 x 23 x 9 cm 200

F(1)

	-500	+500	+2000	+5000
Color 29	0,250 €	0,246 €	0,240 €	0,230 €
	0,300 €	0,296 €	0,290 €	0,280 €



29 01 60 55 56 02

ARCE_7538

Bolsa de papel de 110 g/m². Asas cortas reforzadas de diseño rizado.

25 x 31 x 11 cm 200

F(1)

	-500	+500	+2000	+5000
Color 29	0,280 €	0,270 €	0,260 €	0,250 €
	0,330 €	0,320 €	0,310 €	0,300 €

ASAS DE ALGODÓN 0

MILVUS_7561

Bolsa de resistente papel laminado con asas de algodón.

32 x 37,5 cm 1 250

F(1)

-500	+500	+2000	+5000
1,70 €	1,64 €	1,58 €	1,48 €

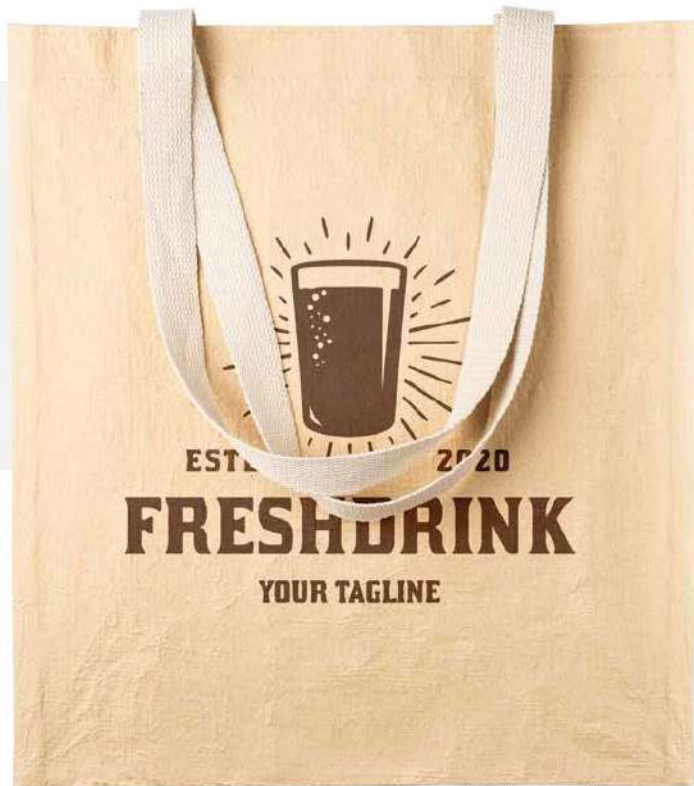

MILANA_7607

Nevera de papel laminado de diseño clásico, interior isotérmico de aluminio y solapa con cierre de cremallera. Práctica asa de transporte incluida.

19 x 13,5 x 14 cm 25 100

F(1)

-500	+500	+2000	+5000
2,54 €	2,42 €	2,32 €	2,20 €

neveras

INTERIOR
ISOTÉRMICO



03

60

05

226

SERRETA_ 7606

Bolsa nevera de papel laminado, con interior isotérmico de aluminio. Solapa con cierre de velcro y práctica asa de transporte a color.

20 x 25 x 10 cm 50 100

F(1)

-500	+500	+2000	+5000
2,04 €	1,98 €	1,90 €	1,78 €



KEMER_ 7600

Bolsa nevera de papel laminado con interior isotérmico de aluminio. Solapa y bolsillo exterior con cierre de velcro.

19 x 32 x 12 cm 25 100

F(1)

-500	+500	+2000	+5000
2,12 €	2,03 €	1,94 €	1,85 €



new.

new **kemer**

new/sidney



SIDNEY_ 7176

Mochila realizada en poliéster reciclado RPET 600D con diseño vigoré . Cuerpo y bolsillos interiores acolchados ideal para portátil y tablet. Doble compartimento y bolsillos laterales. Asas acolchadas.

31 x 45 x 13 cm 1 20

G(1), N(8)

-500	+500	+2000	+5000
19,98 €	19,30 €	18,60 €	17,90 €



58

255

MALMO_ 7106

Mochila realizada en poliéster reciclado RPET 600D con diseño vigoré. Cuerpo y bolsillo interior acolchados ideal para portátil. Doble compartimento con cremallera impermeable y bolsillo exterior. Asas acolchadas y cinta para trolley.

31 x 42 x 12 cm 1 20

G(1), N(8)

-500	+500	+2000	+5000
20,60 €	19,50 €	18,80 €	18,10 €



new.



100% RPET

Material realizado a partir de botellas de plástico recicladas



58



255

KALMAR_7500

Portadocumentos acolchado para portátil realizado en poliéster reciclado RPET 600D con diseño vigoré. Dos compartimentos con cremallera impermeable. Asas de transporte y cinta bandolera ajustable a juego. Incluye cinta para trolley.

37 x 28 x 5 cm 1 30

F(1), N(8)

-500	+500	+2000	+5000
13,40 €	13,00 €	12,60 €	12,10 €



new.

cooler bags

new.



243



255



243



255

MARLOX_ 7609

Nevera XL de poliéster reciclado RPET con diseño vigoré. Doble compartimento y bolsillo frontal. Interior isométrico. Incluye cinta de transporte ajustable.

25,5 x 16 x 11 cm

1

25

G(1), N(8)

-500	+500	+2000	+5000
7,90 €	7,70 €	7,44 €	7,22 €

BISMAR_ 7608

Nevera de poliéster reciclado RPET con diseño vigoré. Bolsillo frontal e interior isotérmico. Incluye cinta de transporte ajustable.

25 x 15,5 x 15,5 cm

1

60

G(1), N(8)

-500	+500	+2000	+5000
5,90 €	5,70 €	5,44 €	5,22 €



01

60

05



226

02

**LARUS_ 7550**

Mochila de cordones realizada en suave poliéster reciclado 210D con esquinas reforzadas.

34 x 42 cm 50 300

F(1), R

-500	+500	+2000	+5000
1,24 €	1,19 €	1,15 €	1,11 €

100% RPET bags

Material realizado a partir de botellas de plástico recicladas



01

60

05

226

02

BUBO_ 7547

Necesar de dos compartimentos con cremalleras y cinta de transporte a juego. Realizado en poliéster reciclado RPET 210D.

21 x 13 x 8 cm 20 100

F(1), N(8), O

-500	+500	+2000	+5000
2,68 €	2,58 €	2,48 €	2,38 €



PANTALA_7549

Bolsa de la compra plegable realizada en suave poliéster reciclado 210T. Práctico bolsillo para su plegado incluido.

33 x 46 x 8 cm 20 400

F(1), G(1), R

-500	+500	+2000	+5000
1,40 €	1,36 €	1,31 €	1,24 €



ADAL_7544

Monedero con 2 bolsillos realizado en agradable polipiel RPET con cremalleras a juego. Anilla llavero incluida en el interior.

10,5 x 9 cm 10 500

D(1), L1

-500	+500	+2000	+5000
0,680 €	0,640 €	0,600 €	0,580 €

100% RPET

Material realizado a partir de botellas de plástico recicladas



01

60

05

226

ORCA_7535

Bolsa reutilizable cosida de acabado laminado mate. Fabricada en resistente non-woven RPET de 100 g/m² con asas reforzadas y ribetes a juego.

42 x 35 x 15 cm 10 200

F(1)

-500	+500	+2000	+5000
1,53 €	1,46 €	1,40 €	1,34 €



01

03

31

60



05

226

02

40

PHOCA_7534

Bolsa reutilizable cosida de acabado laminado mate. Fabricada en resistente non-woven RPET de 100 g/m² con asas reforzadas.

41 x 37 cm 10 250

F(1)

-500	+500	+2000	+5000
0,910 €	0,870 €	0,830 €	0,790 €

PANA_4097



SOTOS_4100



FENGI_4035

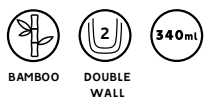

PANA_4097

Taza de acero inoxidable doble pared con exterior en bambú natural. Incluye tapa dosificadora. Capacidad 340 ml. Presentada en caja diseño eco.

10,8 x Ø8,2 cm 1 50
F(1), L2

-500	+500	+2000	+5000
13,50 €	12,90 €	12,40 €	11,80 €



SOTOS_4100

Bidón de acero inoxidable 304 con tapón de bambú. Incluye cinta para transporte. Capacidad 600 ml. Presentado en caja diseño.

22 x Ø6,3 cm 1 50
F(1), L2

-500	+500	+2000	+5000
7,36 €	7,10 €	6,86 €	6,60 €

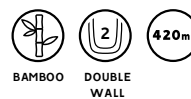

FENGI_4035

Termo en acero inoxidable 304 de doble pared y bambú. Capacidad 420 ml. Incluye cinta de transporte. Presentación en caja diseño eco.

25,5 x Ø6 cm 1 25
F(1), L2

-500	+500	+2000	+5000
15,60 €	15,00 €	14,40 €	13,80 €

KINATA_4032



YABA_4033



bamboo collection

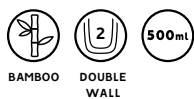

KINATA_ 4032

Termo de acero inoxidable 304 doble pared. Pared exterior en bambú natural. Capacidad 500 ml. Presentación en caja diseño eco.

24,5 x Ø6,9 cm 1 30

F(1), L2

-500	+500	+2000	+5000
13,80 €	12,44 €	11,86 €	11,30 €

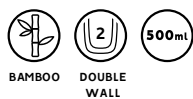

YABA_ 4033

Vaso de acero inoxidable 304 con pared exterior de bambú natural. Capacidad 500 ml. Presentación en caja diseño eco.

17,5 x Ø8,2 cm 1 50

F(1), L2

-500	+500	+2000	+5000
9,70 €	9,26 €	8,86 €	8,40 €

**SAMBAL_ 4061**

Fiambreira de cristal borosilicato con tapa de bambú y banda de silicona. 900 ml de capacidad. Presentación en caja diseño eco.

20 x 6 x 15 cm 1 20

E(1), L2

-500	+500	+2000	+5000
9,70 €	9,28 €	8,80 €	8,50 €

**coco_ 4081**

Taza de cristal borosilicato con tapa y cuchara de bambú. 420 ml de capacidad. Presentación en caja diseño eco.

9,5 x Ø8 cm 1 36

F(1), C(4), L2

-500	+500	+2000	+5000
7,20 €	6,20 €	5,80 €	5,60 €



bamboo products

**TRILBY_ 4020**

Bidón de cristal de 450 ml con tapón de bambú y cintra de transporte en acabado natural. Presentación en caja diseño eco.

19,7 x Ø6,4 cm 1 50

F(1), L2

-500	+500	+2000	+5000
3,10 €	2,98 €	2,85 €	2,70 €



new.

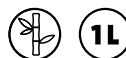

BAMBOO

DAIKON_ 4103

Fiambreira de acero inoxidable 304 con tapa de bambú. Sistema de cierre mediante hebillas laterales. Capacidad 1L. Presentación en caja diseño eco.

19,4 x 6,8 x 13,1 cm

1

20

E(1), L2

-500	+500	+2000	+5000
13,40 €	12,90 €	12,40 €	11,80 €



BAMBOO

KORLAN_ 4066

Fiambreira de acero inoxidable 304 con tapa de bambú y banda de seguridad en poliéster. Capacidad 800 ml. Presentación en caja diseño eco.

15,8 x 6,1 x 11,9 cm

1

30

E(1), L2

-500	+500	+2000	+5000
10,90 €	10,40 €	9,90 €	9,30 €



BAMBOO

COLMER_ 4117

Set de cubiertos de bambú natural presentados en funda de algodón natural con cordón autocierre. Incluye tenedor, cuchillo y cuchara.

6,5 x 1 x 22 cm

100

300

F(1), B(4), L1, N(8)

-500	+500	+2000	+5000
1,94 €	1,86 €	1,78 €	1,70 €



new.



BUSTAN_4062

Vaso reutilizable de PLA con tapa enroscable y 450 ml de capacidad.

13,5 x Ø9,4 cm 1 50

F(1)

-500	+500	+2000	+5000
3,52 €	3,42 €	3,26 €	3,16 €



NUTRI_4022

Vaso de papel de 500 ml. Capa interior de PLA. Biodegradable / compostable.

13,4 x Ø8,9 cm 50 1000

C(1)

-500	+500	+2000	+5000
0,220 €	0,210 €	0,200 €	0,180 €



PARCHA_4063

Taza reutilizable de PLA con 350 ml de capacidad.

8,8 x Ø7,9 cm 50 100

E(4)

-500	+500	+2000	+5000
2,82 €	2,72 €	2,60 €	2,50 €

PLA products



YOBO_4065

Fiambarrera realizada en PLA con cinta de ajuste en silicona. Tenedor, cuchara y cuchillo incluidos. Capacidad 1 lL

19,1 x 7,4 x 11,8 cm 1 40

E(1)

-500	+500	+2000	+5000
11,68 €	11,18 €	10,72 €	10,20 €



rpet bottle

600ml



VALSAN_ 4067

Bidón de RPET con cuerpo en color translúcido. Capacidad 600 ml. Cinta de transporte incluida. Presentación en caja diseño eco.

21,5 x Ø6,5 cm 1 50

F(1), L2

-500	+500	+2000	+5000
3,00 €	2,86 €	2,76 €	2,60 €



00



31



60



226



05



02



01



251



02

new.

new kale



KALE_ 4105

Bidón térmico de acero inoxidable 304 doble pared y base de corcho. Capacidad 520 ml. Presentación en caja diseño.

27 x Ø7,1 cm 1 30

F(1), L2

-500	+500	+2000	+5000
11,96 €	11,24 €	10,76 €	10,28 €

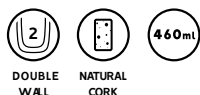

TAYOX_ 4056

Termo de acero 304 doble pared con infusor de té y base de corcho. Capacidad 460 ml. Presentación en caja diseño.

24,5 x Ø6,4 cm 1 30

F(1), L2

-500	+500	+2000	+5000
11,30 €	10,90 €	10,50 €	10,10 €



01

251

02



CORCHO
NATURALNATURAL
CORK**VENET_ 4091**

Set de vino con accesorios en acero inox, sacacorchos 2 tiempos con cortacápsulas, recogegotas y dosificador. Presentado en estuche de corcho natural con interior acolchado.

4,2 x Ø14,9 cm 1 20

G(1), L2

-500	+500	+2000	+5000
10,74 €	10,34 €	9,90 €	9,44 €



4 ACCESORIOS



food & drink products



4 ACCESORIOS

**COMTE_ 4102**

Set para quesos con 4 utensilios de acero inoxidable y mango de madera. Presentados en práctico estuche de madera con tabla para cortar en la zona superior. Presentación en caja blanca.

3,6 x Ø22 cm 1 10

E(1), L2

-500	+500	+2000	+5000
15,40 €	15,20 €	15,00 €	14,70 €



BAMBOO

SHERRY_ 4088

Abridor imantado de bambú con función posavasos.

1,1 x Ø6 cm 50 500

D(4), L1

-500	+500	+2000	+5000
1,47 €	1,41 €	1,35 €	1,29 €



BAMBOO

ALGOR_ 4113

Set de 4 posavasos de bambú natural. Presentación en caja eco.

11,2 x 11,2 x 3,6 cm 1 20

E(1), L2

-500	+500	+2000	+5000
4,94 €	4,78 €	4,54 €	4,32 €



Coaster set



NATURAL CORK

CHALA_ 4087

Posavasos de corcho natural.

0,3 x Ø10 cm 500 1000

D(1), L2

-500	+500	+2000	+5000
0,190 €	0,186 €	0,180 €	0,170 €



**RODEN_ 4090**

Abridor de acero inoxidable con empuñadura de madera natural.

14,4 x 2,2 x 4 cm 50 200

D(4), L1, W

-500	+500	+2000	+5000
1,20 €	1,16 €	1,10 €	0,970 €

Bottleopeners



BAMBÚ



BAMBOO

new.

SHAKE_ 4078

Abridor de diseño realizado en madera natural con interior de acero inoxidable y troquel redondo para colgar.

17,9 x 4,1 cm 50 200

D(4), L1, W

-500	+500	+2000	+5000
2,48 €	2,38 €	2,28 €	2,18 €

COLINS_ 4111

Abridor de diseño compacto realizado en bambú natural con interior de acero inoxidable y troquel superior para colgar.

10,5 x 1 x 4 cm 50 200

D(4), L1

-500	+500	+2000	+5000
2,28 €	2,18 €	2,08 €	1,98 €



ANGUS4116

BORAN4115

DEVON4114



BAMBOO

DEVON_ 4114

Tabla de cortar de bambú natural. Troquelado para colgar y fácil manejo. Presentación en caja eco.

15,3 x 1 x 20 cm 1 50

E(1), L2

-500	+500	+2000	+5000
2,14 €	2,10 €	2,00 €	1,90 €



new.



BAMBOO

ANGUS_ 4116

Tabla de cortar de bambú natural con perfil recoge líquidos. Presentación en caja eco.

30 x 1,2 x 20 cm 1 20

E(1), L2

-500	+500	+2000	+5000
5,44 €	5,14 €	4,90 €	4,70 €

new.







BAMBOO

BORAN_ 4115

Tabla de cortar de madera con mango para fácil manejo y cuerda para colgar. Presentación en caja eco.

13,5 x 1 x 40 cm  1  30

 E(1), L2

-500	+500	+2000	+5000
5,38 €	5,14 €	4,96 €	4,74 €





new.



BAMBOO

RABIL_ 3028

Báscula de cocina digital con carcasa frontal de bambú natural. Capacidad máxima de 5 kg. Funciona con 1 pila de botón incluida. Presentación en caja diseño eco.

15 x 1,6 x 21,5 cm  10  20

 E(1), L2, W

-500	+500	+2000	+5000
12,38 €	11,92 €	11,34 €	10,88 €

new **rabil**

new.

MARBEL_ 4109

Llavero de madera natural en dos formatos con terminaciones en elegante polipiel.

8,5 x 0,5 cm 100 800

D(4), L1

-500	+500	+2000	+5000
0,500 €	0,480 €	0,460 €	0,440 €



982

983

new.

BUDAN_ 4054

Llavero de madera natural. Especial para grabado láser.

10,4 x Ø5 cm 200 800

D(4), L1

-500	+500	+2000	+5000
0,320 €	0,310 €	0,300 €	0,290 €

0,5 x Ø5 cm



982

983

6 x 0,3 x 3,5 cm



4 x 0,5 x 6 cm

981

0,5 x Ø5 cm

982



NATURAL CORK

HIBIS_ 4053

Llavero de corcho natural.

3,9 x 8,1 x 0,6 cm 200 800

D(1), L1

-500	+500	+2000	+5000
0,478 €	0,448 €	0,428 €	0,408 €



3 x 8,8 x 0,6 cm

Ø3,9 x 0,6 cm

SILA_ 4092

Llavero de madera natural en dos formatos con anilla metálica. Ideal para marcaje en láser.

7,2 x 0,6 cm 100 1000

D(4), L1

-500	+500	+2000	+5000
0,380 €	0,370 €	0,360 €	0,350 €



05

new.



NATURAL CORK

YATE_ 4108

Llavero de corcho flotante con resistente cuerda en poliéster.

9 x 1,5 x 4 cm 50 400

D(4), L1

-500	+500	+2000	+5000
1,76 €	1,64 €	1,56 €	1,46 €

soportes de bambú



BAMBOO

STELO_ 4094

Llavero con función soporte para el móvil realizado en bambú.

14,6 x 1,4 x 2,6 cm

100

500

D(4), L1, W

-500 +500 +2000 +5000

0,930 € 0,890 € 0,850 € 0,830 €



BAMBÚ



SOPORTE



BAMBOO

ANTIX_ 3055

Soporte para dispositivos móviles, tablet o smartphone, realizado en bambú natural.

6 x 1,9 x 8,3 cm

50

200

D(4), L2, W

-500 +500 +2000 +5000

1,32 € 1,28 € 1,24 € 1,18 €



BAMBOO

BONCER_ 4110

Llavero de bambú natural con función de soporte para móvil.

8,5 x 0,8 x 2,9 cm

100

600

D(4), L1

-500 +500 +2000 +5000

0,980 € 0,960 € 0,940 € 0,890 €

new.





29

13

GALAXY_ 7063

Sombrero de paja natural con banda confort interior.

250 Consultar

-500	+500	+2000	+5000
1,14 €	1,10 €	1,06 €	1,04 €



COMET_7013

naturalhats



new.



29



02

LEVY_ 7014

Sombrero de fibra natural de gran calidad con banda confort interior.

25 100 Consultar

-500	+500	+2000	+5000
1,98 €	1,92 €	1,83 €	1,74 €



BAMBOO

ORBIT_ 3098

Pulsera de algodón natural con cierre de seguridad (no retornable) en bambú.

35 x 1,5 cm 100 2000

D(1)

-500	+500	+2000	+5000
0,620 €	0,590 €	0,570 €	0,550 €

new.



ROOMER_ 7052

Lanyard de algodón con mosquetón.

2 x 50 cm 100 800

F(1), N(8)

-500	+500	+2000	+5000
0,480 €	0,470 €	0,450 €	0,410 €

100% cotton

SUBLIMACIÓN

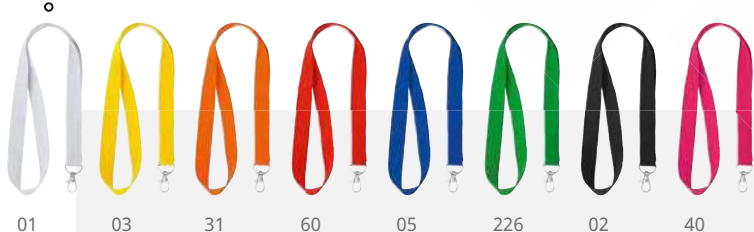

01 03 31 60 05 226 02 40

ECOHOST_ 7055

Lanyard de RPET con mosquetón.

2 x 50 cm 100 800

F(1), N(8), R

-500	+500	+2000	+5000
0,360 €	0,350 €	0,340 €	0,330 €



100% RPET

Hecho a partir de botellas de plástico recicladas





01 60 05 226

**KORA_ 9945**

Cepillo de dientes con cuerpo de PLA. Cerdas blancas de dureza suave. Presentación en caja eco.

18,4 x 1,6 x 1,4 cm 100 600

C(1)

-500	+500	+2000	+5000
0,980 €	0,960 €	0,940 €	0,920 €



KORA



BAMBOO

FRESH_ 9923

Cepillo dental con cuerpo realizado en bambú y cerdas blancas de dureza suave. Libre de aditivos BPA y 100% biodegradable. Presentación en caja diseño de cartón kraft.

17,5 x 1,6 x 1,3 cm 50 400

C(4), L1

-500	+500	+2000	+5000
0,750 €	0,700 €	0,680 €	0,660 €



WHEAT FIBER

LAPP_ 1230

Bálsamo labial con clásico estuche en forma de barra, realizado en fibra de trigo. Protección SPF15.

7 x Ø1,9 cm 25 500

C(1)

-500	+500	+2000	+5000
0,670 €	0,650 €	0,630 €	0,590 €



belle

NATURAL
CORK**BELLE_ 1231**

Espejo plegable de bolsillo realizado en corcho natural y metal cromado, compuesto por dos espejos, uno normal y otro de aumento. Presentación en caja diseño eco.

2 x Ø6,1 cm 50 200

C(4), L1, W

-500	+500	+2000	+5000
2,50 €	2,40 €	2,30 €	2,20 €



2X

NATURAL
CORK**LIMOSA_ 7545**

Monedero de corcho natural con forro interior y cremallera. Anilla de transporte incluida.

11 x 9 cm 100 800

D(1), L2

-500	+500	+2000	+5000
0,900 €	0,860 €	0,820 €	0,780 €

NATURAL
CORK**VESPULA_ 7546**

Estuche de corcho natural con forro interior de poliéster y cremallera.

23 x 11 x 2 cm 50 200

E(1), L2

-500	+500	+2000	+5000
1,75 €	1,68 €	1,61 €	1,54 €



VOSTOK



VOSTOK_ 5602

Poncho impermeable compostable con capucha y abertura para los brazos. Talla única de adulto: 127 x 102 cm. Fabricado en poliláctico (PLA). Presentación en funda individual de PLA.

127 x 102 cm 50 200

E(1)

-500	+500	+2000	+5000
1,24 €	1,20 €	1,16 €	1,08 €

100% RPET

Hecho a partir de botellas de plástico recicladas



MANGO MADERA



01

60

05

02



WIND-PROOF



KHASI_ 5610

Paraguas plegable de poliéster reciclado 190T RPET con funda a juego. Bastón, varillas y terminaciones en negro. Mango de madera natural. Cierre con velcro a juego y apertura manual.

27,5 x Ø5,8 cm 1 50

G(1), N(8), L2

-500	+500	+2000	+5000
7,50 €	7,16 €	6,80 €	6,50 €



05

58

02



ANTI PILLING

200 g/m²**BRANDON_ 5624**

Manta de forro polar realizada en poliéster reciclado RPET con práctica funda. Tratamiento anti-pilling. 200 g/m².

150 x 120 cm

1

20

G(1), H(1), N(8), O, P

-500	+500	+2000	+5000
10,80 €	10,40 €	9,96 €	9,50 €

recycled**PET**

Material realizado a partir de botellas de plástico recicladas



**TECHNO
LOGY**

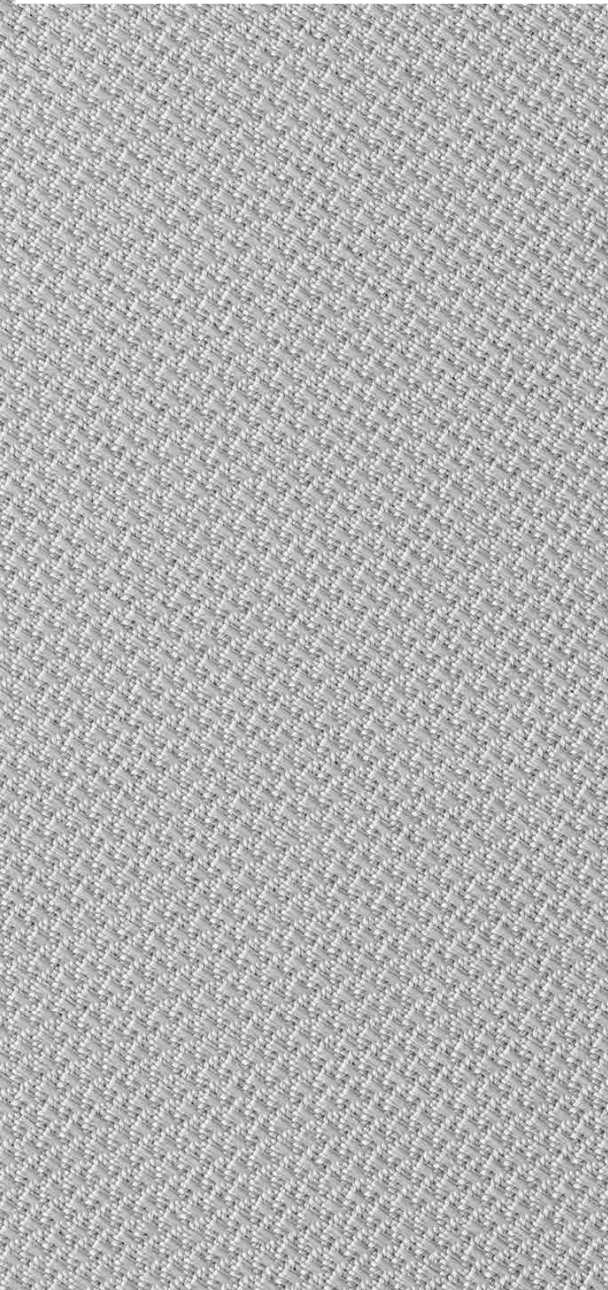

wireless charger & speakers

heldens

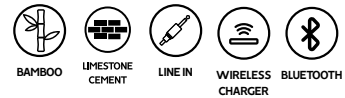

HELDENS_ 3209

Altavoz Bluetooth con base de carga inalámbrica y membrana visible. Cuerpo de cemento piedra caliza y superficie de bambú natural. 5W de potencia de altavoz y salida inalámbrica de DC5V. Batería recargable. Cable incluido. Presentación en caja diseño eco.

11,8 x 7,8 x 6,5 cm 10 20

F(4), L2

-500	+500	+2000	+5000
23,90 €	22,90 €	21,80 €	21,00 €

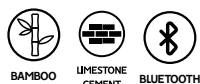

STEVE_ 3208

Altavoz inalámbrico con cuerpo de cemento piedra caliza y superficie de bambú natural. Bluetooth 5.0. 3W de potencia y batería recargable. Cable incluido. Presentación en caja diseño eco.

7,2 x Ø7 cm 15 30

F(4), L2

-500	+500	+2000	+5000
18,40 €	17,60 €	16,70 €	15,90 €



new.

fastcharge



ZATOX_3308

Altavoz bluetooth con base de carga inalámbrica. Cuerpo de fibra de trigo y superficie de bambú natural. 5W de potencia y salida inalámbrica de DC5V. Batería recargable. Presentación en caja diseño eco.

16 x 6 x 5,9 cm 15 30
E(4), L2

-500	+500	+2000	+5000
39,40 €	36,24 €	35,94 €	34,20 €

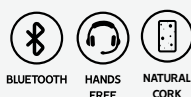

MARCO_3211

Altavoz con cuerpo de corcho natural y membrana visible. Bluetooth 5.0. Potencia 3W. Batería recargable. Cable incluido. Presentación en caja diseño eco.

4,6 x Ø7,9 cm 25 50
F(4), L2

-500	+500	+2000	+5000
12,66 €	12,06 €	11,56 €	11,06 €

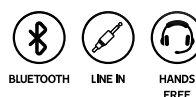

KRAVIZ_3206

Altavoz inalámbrico con cuerpo de madera y membrana visible. Ideal para marcaje en láser. Bluetooth 3.0. 3W de potencia. Batería recargable. Cable incluido. Presentación en caja diseño eco.

6 x 6 x 6 cm 1 50
F(4), L1

-500	+500	+2000	+5000
10,90 €	10,50 €	9,80 €	9,50 €



NERVO_ 3306

Altavoz inalámbrico Bluetooth con cuerpo de bambú natural. Función radio FM, manos libres, ranura para tarjeta Micro SD. 3W de potencia. Batería recargable. Cable incluido. Presentación en caja diseño eco.

5,1 x Ø6 cm 25 50

F(4), L1

-500	+500	+2000	+5000
8,96 €	8,60 €	8,20 €	7,80 €

new.

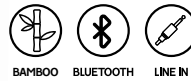

ALESSO_ 3210

Altavoz inalámbrico Bluetooth con cuerpo de ABS, frontal de bambú natural y membrana visible. Incluye asa para transporte de polipiel. 3W de potencia. Batería recargable. Cable incluido. Presentación en caja diseño eco.

7,4 x 7 x 4,5 cm 25 50

E(4), L2

-500	+500	+2000	+5000
15,88 €	15,28 €	14,58 €	13,98 €



HARDWELL_ 3207

Altavoz inalámbrico con cuerpo de ABS blanco y bambú natural. Función radio FM, manos libres, ranura para tarjetas mini SD y 3W de potencia. Batería recargable. Cable incluido. Presentación en caja diseño eco.

4,1 x Ø7,3 cm 1 50

F(4), L1

-500	+500	+2000	+5000
10,20 €	9,80 €	9,10 €	8,70 €



LUZ LED

recycled materials



new.



LUZ LED

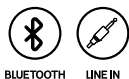

BLUETOOTH LINE IN

ELSON_3311

Altavoz inalámbrico con cuerpo de ABS reciclado. Bluetooth 5.0. Potencia 3W. Batería recargable. Cable incluido. Presentación en caja diseño eco.

6,5 x Ø6,2 cm 25 50

F(4)

-500	+500	+2000	+5000
12,10 €	11,50 €	11,10 €	10,60 €

new.



BLUETOOTH HANDS FREE

CUSTIK_3310

Altavoz inalámbrico con cuerpo tejido en RPET con membrana visible. Bluetooth 5.0. Potencia 3W. Batería recargable. Cable incluido. Presentación en caja diseño eco.

4,6 x Ø7,9 cm 25 50

F(4)

-500	+500	+2000	+5000
14,50 €	13,90 €	13,30 €	12,70 €

vandik

LED



PANEL TÁCTIL



0201

6001

5801

0501



BLUETOOTH



LINE IN



HANDS FREE



CHANGING COLOR LIGHT

VANDIK_ 3203

Altavoz inalámbrico Bluetooth 5.0 en acabado blanco con tacto goma. Combinación con tela a color. Panel de control táctil y luz LED multicolor en la base, con iluminación aleatoria al ritmo de la música. Función manos libres. 3W de potencia. Batería recargable. Cable incluido. Presentación en caja diseño.

10,6 x Ø7,1 cm 1 50

F(2)

-500	+500	+2000	+5000
12,30 €	11,90 €	11,40 €	10,90 €



01

60

05

02



BLUETOOTH



LINE IN



HANDS FREE



RADIO FM



USB PLAYER



MICRO SD

ARMIN_ 3204

Altavoz inalámbrico Bluetooth bicolor. Cuerpo en acabado mate de tacto goma. Asa de transporte, botones y tela a juego. 3W de potencia. Batería recargable. Cable incluido. Presentación en caja diseño.

11,1 x 8,3 x 4,1 cm 1 50

F(2), N(8)

-500	+500	+2000	+5000
8,90 €	8,56 €	8,20 €	7,90 €





VENTOSA



01 03 60 02 40 05



CALVIN_3202

Altavoz inalámbrico con cuerpo de ABS resistente a las salpicaduras de agua. Fijación mediante ventosa. Función manos libres. 3W de potencia. Batería recargable mediante cable Micro USB. Cable incluido. Presentación en caja diseño.

5,5 x Ø8,5 cm 1 50

F(1)

-500	+500	+2000	+5000
4,04 €	3,94 €	3,78 €	3,62 €



MICRO SD



01 31



60 05 02



COX_3200

Altavoz inalámbrico de ABS con acabado en tacto suave. Bluetooth 3.0. 3W de potencia. Función manos libres. Batería recargable. Cable incluido. Presentación en caja diseño.

7,5 x Ø6 cm 1 50

F(4)

-500	+500	+2000	+5000
6,94 €	6,70 €	6,50 €	6,20 €

ACABADO METALIZADO



01 60 05 251 02



GARRIX_3201

Altavoz inalámbrico con cuerpo metálico en acabado mate. Bluetooth 3.0. Función radio FM y manos libres. 3W de potencia. Batería recargable. Cable incluido. Presentación en caja diseño.

5 x Ø5,9 cm 25 50

F(4)

-500	+500	+2000	+5000
5,40 €	5,00 €	4,80 €	4,60 €



60 05 02



MOLLER_3205

Altavoz Bluetooth con base de carga inalámbrica. Cuerpo de ABS retroiluminado. Conectelo, coloque su Smartphone y déjelo cargar mientras escucha su música favorita. 3W de potencia de altavoz. Salida inalámbrica DC5V. Cable incluido. Presentación en caja diseño.

4 x Ø6,5 cm 50 100

F(4), W

-500	+500	+2000	+5000
10,50 €	10,20 €	9,80 €	9,40 €

AURICULARES
BLUETOOTH

legrand



LEGRAND_ 3150

Auriculares inalámbricos Bluetooth 5.0 con acabado en tacto goma. Plegables. Acolchado superior y almohadillas en polipiel suave. Laterales en aluminio ideales para marcaje en láser. Panel de control integrado con tecnología estéreo. Función manos libres y radio FM. Batería recargable. Cable incluido. Presentación en caja blanca con fajín de diseño.

19 x 18,5 x 7,7 cm 10 20
F(1), L2

-500	+500	+2000	+5000
19,90 €	18,90 €	18,00 €	17,30 €



RAYEL_ 3151

Auriculares inalámbricos Bluetooth 5.0 con acabado en tacto goma. Plegables. Acolchado superior y almohadillas en polipiel suave. Laterales en aluminio ideales para marcaje en láser. Panel de control integrado con tecnología estéreo. Función manos libres y radio FM. Batería recargable. Cable incluido. Presentación en caja diseño.

19 x 17,5 x 8 cm 10 20
F(1)

-500	+500	+2000	+5000
14,50 €	14,10 €	13,60 €	13,10 €





new.



VALDI_ 3312

Auriculares inalámbricos Bluetooth 5.0 con estuche de carga. Realizados en ABS reciclado y superficie superior de bambú. Panel de control con tecnología táctil integrada en auricular. Función manos libres. Estuche con batería recargable y tapa imantada. Cable Micro USB incluido. Presentación en caja diseño eco.

6,5 x 2,6 x 3,6 cm 1 50

E(4), L2

-500	+500	+2000	+5000
20,30 €	19,20 €	18,40 €	17,60 €



BLUES_ 3026

Auriculares inalámbricos Bluetooth 5.0 con estuche de carga en bambú natural. Botón multifunción táctil integrado en ambos auriculares. Función manos libres. Batería recargable. Cable incluido. Presentación en caja diseño eco.

7,8 x 3,2 x 3,2 cm 50 100

E(4), L2

-500	+500	+2000	+5000
22,30 €	21,30 €	19,90 €	19,30 €



bluetooth auriculares

funk



ESTUCHE DE CARGA

PANTALLA LCD



FUNK_ 3307

Auriculares inalámbricos Bluetooth 5.0 con estuche de carga. Pantalla LED en el estuche y botón multifunción integrado en ambos auriculares. Función manos libres. Estuche con diseño en acabado mate y batería recargable. Cable incluido. Presentación en caja diseño.

6,2 x 2,8 x 4 cm 50 100

E(4), W

-500	+500	+2000	+5000
15,20 €	14,70 €	14,20 €	13,40 €



TECNOLOGÍA DE CARGA INALÁMBRICA



TRAP_ 3025

Auriculares inalámbricos Bluetooth 5.0 con estuche de carga. Botón multifunción integrado en ambos auriculares. Función manos libres. Batería recargable mediante tecnología inalámbrica. Cable incluido. Presentación en caja diseño.

7,5 x 3,2 x 3,2 cm 50 100

E(4), W

-500	+500	+2000	+5000
20,50 €	19,90 €	19,30 €	18,70 €



ESTUCHE DE CARGA



new.



BURAK_ 3309

Auriculares inalámbricos Bluetooth 5.0 realizados en fibra de trigo con estuche de carga. Panel de control con tecnología táctil integrado en auricular. Función manos libres. Estuche con batería recargable y tapa imantada. Cable incluido. Presentación en caja diseño eco.

6,8 x 2,2 x 4,5 cm

50

100

E(4), W

-500	+500	+2000	+5000
14,00 €	13,50 €	12,90 €	12,40 €



TÁCTIL

new burak

ESTUCHE DE CARGA



TÁCTIL



FERRY_ 3305

Auriculares inalámbricos Bluetooth 5.0 con estuche de carga. Elegante acabado en blanco brillante. Panel de control con tecnología táctil integrado en auricular. Función manos libres. Estuche con batería recargable y tapa imantada. Cable incluido. Presentación en caja diseño.

6,8 x 2,2 x 4,5 cm

50

100

E(4), W

-500	+500	+2000	+5000
11,10 €	10,60 €	10,10 €	9,60 €



01

02



BLUETOOTH HANDS FREE



SAM_3304

Auricular individual inalámbrico con soporte USB magnético de carga. Batería recargable. Presentado en un práctico estuche de PU con cremallera.

8 x 3,9 x 6,1 cm 50 200

E(1)

-500	+500	+2000	+5000
6,50 €	6,20 €	5,80 €	5,50 €



01 03 31 60 05 226 02 40



01 60 05 02

PUNK_3301

Auriculares presentados en práctica funda transparente de PVC con autocierre. Conexión Jack 3,5 mm. Cable con botón de seguridad incluido.

8 x 7,8 x 1,2 cm 50 500

E(1)

-500	+500	+2000	+5000
0,470 €	0,460 €	0,450 €	0,430 €

AOKI_3300

Auriculares en estuche de PS. Conexión Jack 3,5 mm. Cable con botón de seguridad incluido. Incluye 3 pares de fundas de diferentes medidas.

7 x 7 x 2 cm 50 500

D(1), W

-500	+500	+2000	+5000
0,670 €	0,650 €	0,630 €	0,590 €

auriculares deportivos

TECHNOLOGY



01



02



KURA_3302

Auriculares inalámbricos con panel de control y micrófono incorporado. Sonido estéreo. Presentación en un práctico estuche de polipiel con cremallera. Batería recargable. Cable incluido.

3,9 x Ø8 cm 50 200

E(1), G(4)

-500	+500	+2000	+5000
8,00 €	7,70 €	7,40 €	7,10 €



IMANTADOS



FLUME_3303

Auriculares inalámbricos de aluminio con panel de control y micrófono incorporado. Cierre magnético en los laterales. Sonido estéreo. Batería recargable. Cable incluido. Presentación en caja diseño.

7,5 x 13,6 x 3 cm 50 100

E(4)

-500	+500	+2000	+5000
6,70 €	6,50 €	6,30 €	5,96 €



60

02

05

251

4K CAMERA discovery



DISCOVERY_2100

Cámara deportiva con tecnología de vídeo HD 4K y conexión Wi-Fi. Pantalla LCD 2" con función cámara de fotos Full HD 1080P. Incluye resistente carcasa sumergible hasta 30 m y diversos accesorios de acople multifunción. Batería extraíble recargable. Cable incluido. Presentación en caja diseño.

6 x 4,2 x 3 cm 1 20

K(4)



-500	+500	+2000	+5000
56,00 €	53,80 €	51,80 €	49,80 €

smartwatch

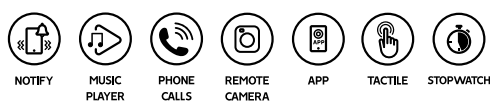

NORA_ 3405

Reloj inteligente con funciones de actividad. Correa de TPU ajustable y pantalla IPS táctil. Monitorización de frecuencia cardíaca y control de llamadas. Conexión Bluetooth con APP para iOS y Android. Cable USB de carga incluido. Presentación en caja diseño.

27 x 1,2 x 3,9 cm  1  50

I(1), L2

-500	+500	+2000	+5000
35,00 €	33,00 €	32,00 €	31,00 €

smart watch



willman



- 
HEART RATE
MONITOR
- 
CALORIES
COUNTER
- 
PEDOMETER
- 
SLEEP
CONTROL
- 
BLUETOOTH
- 
REMOTE
CAMERA
- 
APP
- 
NOTIFY

WILLMAN_ 3402

Reloj inteligente con funciones de actividad. Cuerpo en TPU y pantalla a color TFT 1,3" con USB de carga integrado. Correa ajustable de silicona y hebilla metálica. Monitorización de frecuencia cardíaca. Conexión Bluetooth con APP para iOS y Android. Presentación en caja diseño.

 25 x 1,1 x 3,4 cm

 1

 50

 I(1), L2

-500	+500	+2000	+5000
21,60 €	20,60 €	19,80 €	19,00 €



DRACO_ 3401

Reloj inteligente con funciones de actividad. Cuerpo en TPU y pantalla a color TFT. Correa ajustable de silicona y hebilla metálica. Monitorización de frecuencia cardíaca. Conexión Bluetooth con APP para iOS y Android. Cable USB de carga incluido. Presentación en caja diseño.

26 x 1,9 x 1,2 cm 50 100

I(1), L2

-500	+500	+2000	+5000
15,40 €	14,90 €	14,30 €	13,80 €



CALORIES Pedometer
COUNTER

FORNAX_ 3400

Reloj multifunción con pantalla LCD y correa ajustable de silicona. Pila botón incluida. Presentación en práctico estuche transparente ideal para marcaje.

25,5 x 2,7 x 1,5 cm 50 100

E(1), F(1), W

-500	+500	+2000	+5000
2,60 €	2,50 €	2,30 €	2,20 €





icarus

RELOJ &
CARGADOR
INALÁMBRICO



- 
WIRELESS
CHARGER
- 
ALARM
- 
TEMPERATURE
- 
TIME & DATE

ICARUS_ 3029

Reloj con cargador inalámbrico realizado en madera MDF. Funciones: hora, fecha, alarma y temperatura. 3 modos de iluminación. Cable incluido. Presentación en caja diseño eco.

 16 x 2,9 x 7,5 cm

 1

 50

 E(4), L2, W

-500	+500	+2000	+5000
29,80 €	28,80 €	27,80 €	26,30 €

estaciones meteorológicas



new.



new.

**KELVIN_ 3004**

Estación metereológica con carcasa frontal de bambú. Función reloj, calendario y alarma con sensores de temperatura y humedad. Funciona con 2 pilas AAA no incluidas. Presentación en caja diseño eco.

13 x 13 x 2,4 cm 20 40

F(4),L2,W

-500	+500	+2000	+5000
12,90 €	12,40 €	11,90 €	11,40 €

**CELSIUS_ 3016**

Estación metereológica con carcasa frontal de bambú natural. Función reloj con sensores de temperatura y humedad. Funciona con 2 pilas AAA no incluidas. Presentación en caja diseño eco.

8,6 x 12 x 2 cm 25 50

F(4),L1,W

-500	+500	+2000	+5000
11,56 €	11,06 €	10,60 €	10,20 €

línea corcho

CARGA
INALÁMBRICA



WIRELESS
CHARGER

NATURAL
CORK

ALAX_ 3030

Alfombrilla con cargador inalámbrico integrado. Suave superficie plegable de corcho natural con base antideslizante. DCSV. Cable incluido. Presentación en caja diseño eco.

26 x 20,3 cm 1 50

F(1),L2

-500	+500	+2000	+5000
12,80 €	12,30 €	11,80 €	11,30 €



alax

promet

CARGA INALÁMBRICA

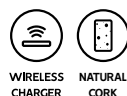

WIRELESS
CHARGER

NATURAL
CORK



WIRELESS
CHARGER

NATURAL
CORK

WHEAT
FIBER

PROMET_ 3032

Portalápices con cargador inalámbrico integrado. Realizado en corcho natural. Incluye 2 puertos USB adicionales en la parte trasera. DCSV. Cable incluido. Presentación en caja diseño eco.

15,2 x 10,6 x 10,6 cm 1 20

F(1),L2

-500	+500	+2000	+5000
19,80 €	19,38 €	18,96 €	18,54 €



SULAC_ 3031

Cargador inalámbrico con cuerpo de corcho natural y fibra de trigo. DCSV. Cable incluido. Presentación en caja diseño eco.

1,9 x Ø9 cm 50 100

E(4)

-500	+500	+2000	+5000
8,94 €	8,60 €	8,30 €	7,94 €



cargadores inalámbricos

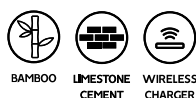

MARS_3021

Cargador inalámbrico con cuerpo de bambú natural y base de cemento piedra caliza. Coloque su Smartphone sobre el y déjelo cargar. Compatible con dispositivos con tecnología inalámbrica. DC5V. Cable incluido. Presentación en caja diseño eco.

9,4 x 12,5 x 9,4 cm 15 30

E(4), L2

-500	+500	+2000	+5000
16,90 €	16,20 €	15,50 €	14,80 €

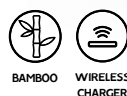

GRAVITY_3022

Cargador inalámbrico con cuerpo de bambú natural. Coloque su Smartphone sobre el y déjelo cargar. Compatible con dispositivos con tecnología inalámbrica. DC5V. Cable incluido. Presentación en caja diseño eco.

7 x 11,5 x 8 cm 25 50

E(4), L2

-500	+500	+2000	+5000
13,72 €	13,22 €	12,52 €	11,92 €

new.



LYRA_3010

Soporte de bambú natural para móviles. Ranura inferior para cable de carga. Incluye 2 partes de fácil montaje.

8 x 8,1 x 12 cm 50 100

D(4), L2, W

-500	+500	+2000	+5000
1,98 €	1,88 €	1,80 €	1,72 €

línea bambú

CARGA INALÁMBRICA



CORE_3024

Cargador inalámbrico de bambú natural integrado en bandeja organizadora. Compatible con dispositivos con tecnología de carga inalámbrica. DC5V. Cable blanco incluido. Presentación en caja diseño eco.

27 x 1,5 x 14,5 cm 1 20

E(4), L2, W

-500	+500	+2000	+5000
15,48 €	14,78 €	14,08 €	13,38 €

new.



2 SALIDAS USB 3.0

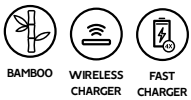

NEBULA_3001

Cargador inalámbrico con cuerpo de bambú natural. Capacidad de carga de hasta 3 dispositivos simultáneamente. Compatible con modelos con tecnología de carga inalámbrica. DC5V. Salida corriente USB DC5V/2.1A. Presentación en caja diseño eco.

9 x 0,9 x 9 cm 25 50

E(4),L2,W

-500	+500	+2000	+5000
10,08 €	9,06 €	8,72 €	8,36 €



CARGA INALÁMBRICA

GAMMA_3027

Cargador inalámbrico con soporte para móviles y tablets realizado en bambú natural. DC5V. Cable de 1m incluido. Presentación en caja diseño eco.

12,5 x 8 x 1,6 cm 50 100

E(4),L2

-500	+500	+2000	+5000
11,60 €	11,10 €	10,70 €	10,30 €



cargadores inalámbricos



999



01



02

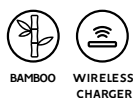

SOYUZ_ 3018

Cargador inalámbrico con cuerpo de ABS blanco y superficie superior de bambú natural. Coloque su Smartphone sobre el y déjelo cargar. Compatible con dispositivos con tecnología inalámbrica. DC5V. Cable incluido. Presentación en caja diseño eco.

1 x Ø6 cm 50 200

E(4), L2, W

-500	+500	+2000	+5000
5,70 €	5,40 €	5,20 €	5,00 €



FALCON_ 3005

Cargador inalámbrico con cuerpo en aluminio. Conéctelo, coloque su Smartphone sobre el y déjelo cargar. Una luz le indicará que está cargando. Compatible con dispositivos con tecnología de carga inalámbrica. DC5V/1.0A. Cable incluido. Presentación en caja diseño.

0,7 x Ø9,8 cm 50 100

E(4), L2, W

-500	+500	+2000	+5000
9,20 €	8,86 €	8,56 €	8,20 €



recycledabs



new.



new.



WIRELESS CHARGER FAST CHARGER

ZIBAL_2999

Cargador inalámbrico con cuerpo en ABS reciclado y superficie superior en tejido RPET. Coloque su smathphone sobre él y déjelo cargar. Compatible con modelos de tecnología inalámbrica DC5V. Incluye cable micro USB. Presentación en caja diseño eco.

0,7 x Ø10 cm 50 100

F(1), N(8)

-500	+500	+2000	+5000
9,70 €	9,30 €	8,90 €	8,50 €

new dilbar



WIRELESS CHARGER FAST CHARGER 8000 mAh

DILBAR_3356

Batería externa de 8000 mAh con cuerpo de ABS reciclado y superficie superior en tejido RPET. Salida de corriente USB DC5V/2.1A. Inalámbrica DC5V. Incluye cable Micro USB. Presentación en caja diseño eco.

6,7 x 1,2 x 12,6 cm 25 50

F(1), N(8)

-500	+500	+2000	+5000
22,30 €	21,30 €	20,30 €	19,30 €

wirelesscharge



60



05



02



WIRELESS CHARGER FAST CHARGER

LANDER_ 3003

Base de carga inalámbrica para Smartphone. Conectela, coloque su smartphone sobre ella y déjelo cargar. Compatible con dispositivos con tecnología de carga inalámbrica. DC5V/1.0A. Cable incluido. Presentación en caja diseño.

1 x Ø7 cm 50 200

E(4), W

-500	+500	+2000	+5000
3,20 €	3,00 €	2,80 €	2,70 €



ESPECIAL PARA IMPRESIÓN DIGITAL



02



01



WIRELESS CHARGER

HAL_ 3353

Batería externa de ABS para carga inalámbrica con 5000 mAh. Función de fijación mediante ventosas. Indicador de carga LED. Salida corriente USB DC5V/2.1A. Inalámbrica DC5V/1A. Incluye cable Micro USB. Presentación en caja diseño.

10,4 x 6,5 x 1,6 cm 25 50

F(4), W

-500	+500	+2000	+5000
13,40 €	12,80 €	12,30 €	11,80 €



01 03 60 05 02 226



LIGHT

DROIDE_ 3354

Batería externa solar de 4000 mAh. Indicador de carga LED y luz. Salida de corriente DC5V/2.1A. Incluye cable Micro USB. Presentación en caja diseño.

7,5 x 14,5 x 1,5 cm 20 40

D(2)

-500	+500	+2000	+5000
13,30 €	12,70 €	12,20 €	11,60 €

MOSQUETÓN INCLUIDO

ZONA DE IMPRESIÓN



new.

especial
grabado
light logo

PANTALLA LCD



TYPE C



02 60 05 55 226



LIGHT UP

WALLE_ 3351

Batería externa en ABS de 5000 mAh. Acabado tacto goma con luz LED interior, ideal para marcaje láser. Pantalla digital con indicador de carga. Salida de corriente DC5V/2.1A. Incluye cable Micro USB. Presentación en caja diseño.

9,4 x 6,2 x 1,3 cm 25 50

E(4), L2, W

-500	+500	+2000	+5000
11,20 €	10,80 €	10,40 €	9,90 €



BAMBOO

ROSSUM_ 3355

Batería externa de 5000 mAh con cuerpo de ABS blanco y superficie superior de bambú. Salida corriente USB DC5V/2.1A. Incluye cable Micro USB. Presentación en caja diseño eco.

10,1 x 1,5 x 6,3 cm 25 50

E(4), L2, W

-500	+500	+2000	+5000
17,30 €	16,70 €	16,20 €	15,70 €

powerbanks

ESPECIAL PARA
IMPRESIÓN DIGITAL





0101 6001 0501 22601



ROBBIE_ 3352

Batería externa de ABS bicolor con 10000 mAh. Indicador de carga LED. Salida de corriente DC5V/2.1A. Incluye cable Micro USB. Presentación en caja diseño.

14,4 x 1,4 x 7,7 cm  10  40

 E(4), W

-500	+500	+2000	+5000
10,70 €	10,40 €	10,10 €	9,80 €





01 60 05 251 02



BENDER_ 3350

Batería externa de aluminio con capacidad 2600 mAh. Indicador de carga LED. Incluye cable con conexión USB y Micro USB. Presentación en caja diseño.

9,4 x 2,1 x 2,2 cm  25  100

 D(4), L2

-500	+500	+2000	+5000
3,90 €	3,70 €	3,56 €	3,30 €



cables cargadores

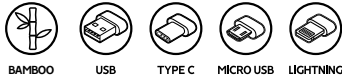

ASTRO_3019

Cable cargador 3 en 1. Cuerpo de ABS y bambú natural. Conexión Micro USB, Tipo C y Lightning. Presentación en bolsa eco con ventana.

16,5 x 1 x 2,1 cm 100 400

D(1), L1

-500	+500	+2000	+5000
3,60 €	3,46 €	3,30 €	3,16 €

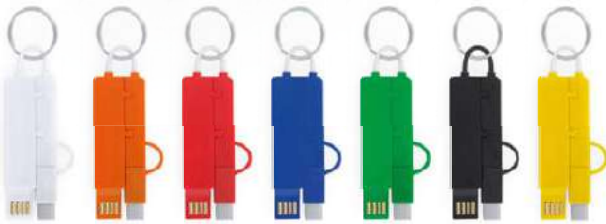

01 31 60 05 226 02 03

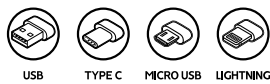

CRUX_3009

Cable cargador con llavero 3 en 1. Cuerpo en ABS de diseño plano, ideal para marcaje. Conexión Micro USB, Tipo C y Lightning.

3,4 x 8,5 x 0,5 cm 100 500

C(4)

-500	+500	+2000	+5000
2,15 €	2,00 €	1,90 €	1,78 €



01 02 05 226 31 60

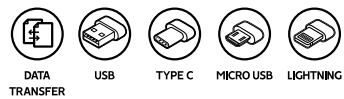

CETUS_3008

Cable cargador-sincronizador imantado con llavero 3 en 1. Conexión Micro USB, Tipo C y Lightning. Presentación en caja blanca.

1,2 x 6,7 x 1 cm 50 500

C(4)

-500	+500	+2000	+5000
1,96 €	1,90 €	1,84 €	1,78 €

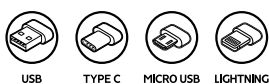

ARIES_ 3006

Llavero con cargador 3 en 1. Cuerpo de ABS en acabado metalizado retroiluminado mediante LED. Ideal para marcaje láser. Conexión Micro USB, Tipo C y Lightning.

1,5 x 13,5 x 1,5 cm 100 600
D(1), L1

-500	+500	+2000	+5000
2,46 €	2,36 €	2,20 €	2,10 €



CANES_ 3007

Cable cargador 3 en 1, presentado en práctico estuche con soporte integrado para Smartphone. Conexión Micro USB, Tipo C y Lightning.

6,7 x 6,8 x 3,3 cm 50 200
E(1), W

-500	+500	+2000	+5000
2,40 €	2,30 €	2,10 €	1,90 €



GORDON_ 3014

Adaptador de viaje universal. Válido para su uso en europa, asia, reino unido, estados unidos y australia. Presentación en caja blanca.

8,2 x Ø4,5 cm 50 100
D(4)

-500	+500	+2000	+5000
2,50 €	2,40 €	2,30 €	2,20 €



BOPP_ 3013

Adaptador de viaje universal de diseño compacto y retráctil, con acabado mate y tacto suave. Válido para su uso en europa, asia, reino unido, estados unidos y australia. 2 puertos USB. Velocidad de carga 2100 mAh. Presentación en caja blanca.

6,1 x 5,6 x 4,5 cm 50 100
D(4), W

-500	+500	+2000	+5000
9,80 €	9,50 €	9,10 €	8,60 €



SUBLIMATION



01



03



60



05



226



02

SIRA_ 3011

Alfombrilla para ratón de diseño plano. Superficie de poliéster suave y base antideslizante de silicona.

22 x 18 x 0,2 cm

100 200

E(1), R

-500	+500	+2000	+5000
0,480 €	0,460 €	0,440 €	0,420 €

personaliza tu escritorio



6001



0101



0501



0202

JERRY_ 3052

Ratón plegable inalámbrico con sensor óptico de precisión. Diseño ergonómico con superficie en tacto goma. 2 pilas AAA no incluidas. Presentación en caja blanca.

10,8 x 3,6 x 6 cm

50 100

E(1), W

-500	+500	+2000	+5000
4,50 €	4,30 €	4,10 €	3,90 €

new.



USB

PLERION_ 3033

Puerto USB con cuerpo en aluminio, acabado bicolor y cable blanco. Incluye 4 puertos USB. Presentación en caja blanca.

8,9 x 3,7 x 2,1 cm

50 200

D(4), L1



60

05

251

02

-500	+500	+2000	+5000
4,38 €	4,26 €	4,08 €	3,96 €



BAMBOO

USB

NEPTUNE_ 3023

Puerto USB con cuerpo de bambú natural y cable en blanco. Incluye 3 puertos USB. Presentación en caja de diseño eco.

8,5 x 1,6 x 4 cm

50 200

D(4), L1, W

-500	+500	+2000	+5000
6,98 €	6,68 €	6,38 €	6,08 €



258



02

05

60

01



KASPER_ 3050

Tapa para cámara de dispositivo móvil o webcam, con mecanismo deslizante y adhesivo 3M reutilizable.

3,2 x 1,3 x 0,1 cm

100

10000

B(1), W

-500	+500	+2000	+5000
0,165 €	0,160 €	0,150 €	0,140 €

tapa webcam

ACOLCHADO

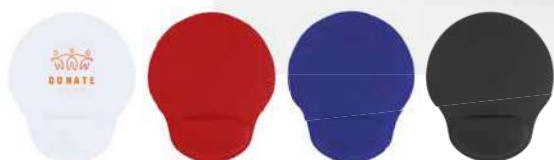

01

60

05

02



02

01

SILVANO_ 3012

Alfombrilla para ratón realizada en poliéster suave con reposamuñecas acolchado. Base antideslizante de silicona.

20,5 x 24,3 x 2 cm

1

100

E(1), N(8), R

-500	+500	+2000	+5000
2,64 €	2,52 €	2,40 €	2,24 €

STUART_ 3051

Ratón inalámbrico con sensor óptico de precisión y botón DPI integrado. Superficie con acabado en tacto goma. 2 pilas AAA no incluidas. Presentación en caja blanca.

11,2 x 2,4 x 5,7 cm

100

200

E(4), W

-500	+500	+2000	+5000
5,40 €	5,20 €	4,90 €	4,60 €



WIRELESS CHARGER FAST CHARGER

2 ACCESORIOS

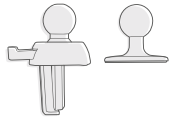

HYDRA_ 3054

Soporte de coche para Smartphone con cargador inalámbrico. Conectelo, coloque el móvil sobre él y deje que se cargue. Compatible con dispositivos con tecnología de carga inalámbrica. Cable y 2 accesorios incluidos. DC5V/1.0A. Presentación en caja diseño.

8,5 x 10 x 9,4 cm



E(1)

-500	+500	+2000	+5000
9,10 €	8,70 €	8,10 €	7,80 €

ORION_ 3053

Soporte magnético de coche para móvil, realizado en aluminio. Presentación en caja diseño.

3 x Ø3,3 cm



F(1), L1

-500	+500	+2000	+5000
1,22 €	1,18 €	1,14 €	1,06 €



01

60

05

226

02

LANCER_ 3002

Cargador para coche en ABS con dos puertos USB. 2100 mAh. Presentación en caja blanca.

6,7 x 2,1 x 2,3 cm



C(4)

-500	+500	+2000	+5000
1,12 €	1,08 €	1,04 €	0,990 €



60

05

02

01

TARDIS_ 3000

Set de cargadores USB, coche y pared, presentados en estuche de PU con cremallera. Velocidad de carga 1000 mAh.

8 x 4,2 x 6,3 cm



C(4), E(1)

-500	+500	+2000	+5000
3,20 €	3,10 €	3,00 €	2,90 €

accesorios movil



BAMBOO

ANTIX_3055

Soporte para dispositivos móviles, tablet o smartphone, realizado en bambú natural.

6 x 1,9 x 8,3 cm 50 200

D(4), L2, W

-500	+500	+2000	+5000
1,32 €	1,28 €	1,24 €	1,18 €



01 02 40 60 05 226 31 03

KETU_3020

Práctico tarjetero de silicona con función soporte para móvil. Incluye cinta adhesiva para adherirlo a la parte trasera del móvil.

5,6 x 9,5 x 0,5 cm 100 500

L1

-500	+500	+2000	+5000
0,530 €	0,510 €	0,490 €	0,470 €



01 60 05 226 02 03

NOSTRO_3015

Soporte para móvil multifunción. Anillo giratorio 360°. Moneda para carro integrada. Adhesivo.

0,6 x Ø3,3 cm 200 1000

B(4), W

-500	+500	+2000	+5000
0,290 €	0,280 €	0,260 €	0,250 €



USB MADE TO ORDER

TARIFA SEMANAL

SOLICITE NUESTRA TARIFA SEMANAL

Modelos con hasta 64Gb de capacidad. Modelos OTG, Conexión 3.0. Diseños personalizados en 2D y 3D.
Presupuestos en 24-48h.



Caja presentación estándar gratis



Servicio de grabación de ficheros



Color pantone especial gratuito
a partir de 500 unidades*
(*Consultar modelos disponibles)



ENTREGA RÁPIDA

En nuestro día a día, las entregas más rápidas se están convirtiendo cada vez más en una necesidad. Consulta nuestros modelos disponibles para entrega rápida.



CUMPLIMIENTO Y COMPROMISO DE CALIDAD

Por encima de todo, tus regalos siempre deben ser seguros. Por eso sólo utilizamos chips originales garantizando así la máxima calidad.



PERSONALIZA TU USB

Precios de tarifa con impresión a 2 colores o láser 1 posición incluida.



CANTIDADES PEQUEÑAS

Disfruta del modelo que más te guste desde tan sólo 100 unidades.

USBstock



16 GB 32 GB

MARVIN_ 4186

Memoria USB de diseño clásico con cuerpo de ABS y clip giratorio metálico. Presentación en caja de cartón blanco mate con ventana.

5,7 x 0,9 x 1,9 cm

50

300

D(4), L1

[Consultar Precio](#)



16 GB

CYLON_ 4187

Memoria USB de aluminio con diseño extraplano en forma de llave. Presentación en estuche metálico con ventana.

5,7 x 0,3 x 2,4 cm

1

200

D(4), L1

[Consultar Precio](#)

16 GB 32 GB

ROY_ 4188

Memoria USB metálica de diseño ultra compacto. Presentación en caja de cartón blanco mate.

3,8 x 0,4 x 1,2 cm

100

1000

D(4), L1

[Consultar Precio](#)



WRITTING
& **OFFICE**



colours



01 03 31 60 05 226 02 40 114 242 48 63

STIX_ 8010

Bolígrafo de ABS con pulsador en variada gama de colores. Disponible en tinta azul y negra.

13,8 x Ø1 cm 50 1000

A(4)

-500	+500	+2000	+5000
0,094 €	0,092 €	0,088 €	0,086 €

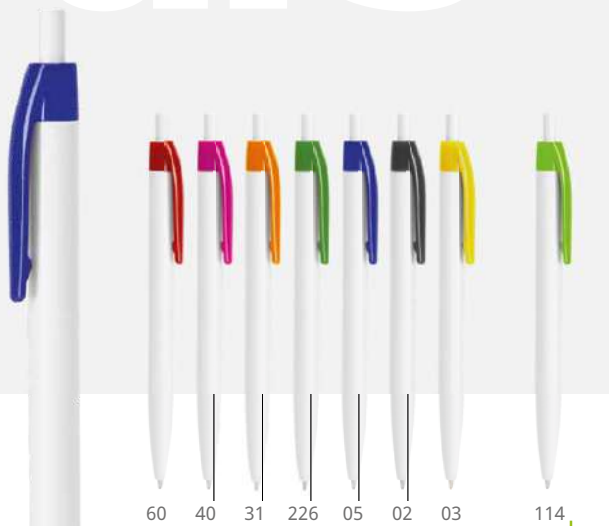

60 40 31 226 05 02 03 114 newcolors

HINDRES_ 8045

Bolígrafo de ABS con pulsador. Cuerpo en color blanco y clip en variada gama de colores. Tinta azul.

13,8 x Ø1 cm 50 1000

A(4)

-500	+500	+2000	+5000
0,096 €	0,094 €	0,090 €	0,088 €

+ antibacterial

ISO 22196

* Material tratado con Iones de Plata que evita la proliferación de las bacterias.



antibacterial ISO 22196

STARK_ 8040

Bolígrafo con cuerpo de ABS anti-bacterias. Tinta azul. Norma ISO 22196.

13,8 x Ø1 cm 50 1000

A(4)

-500	+500	+2000	+5000
0,140 €	0,130 €	0,125 €	0,120 €



29 03 31 60 242 114



WHEAT FIBER

KAMUT_ 8035

Bolígrafo con pulsador realizado en fibra de trigo y ABS. Tinta azul.

13,8 x Ø1 cm 50 1000

A(4)

-500	+500	+2000	+5000
0,120 €	0,114 €	0,108 €	0,100 €

100% ecofriendly



GROVE8029



ALDER8079



COMPER8043



LIANDE8042

WRITING & OFFICE



WHEAT
FIBER

GROVE_ 8029

Bolígrafo pulsador hecho en cartón reciclado, con la punta y el clip en fibra de trigo y ABS. Tinta azul.

14 x Ø1 cm 50 1000

A(4)

-500	+500	+2000	+5000
0,144 €	0,134 €	0,124 €	0,118 €

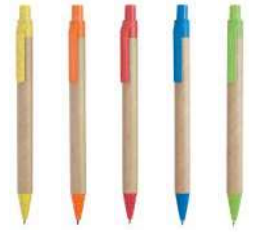

03 31 60 242 114



29 6029 24229 0229



ALDER_ 8079

Bolígrafo con cuerpo de cartón reciclado y PLA. Tinta azul.

13,9 x Ø0,9 cm 50 1000

A(4), W

-500	+500	+2000	+5000
0,220 €	0,210 €	0,190 €	0,176 €



01 60 05 226 02



WHEAT
FIBER



NATURAL
CORK

COMPER_ 8043

Bolígrafo línea eco con cuerpo de corcho y detalles en fibra de trigo. Tinta azul.

14 x Ø1 cm 50 1000

A(4)

-500	+500	+2000	+5000
0,260 €	0,250 €	0,240 €	0,230 €



29 60 242 114 02

LIANDE_ 8042

Bolígrafo de cartón reciclado con capucha. Tinta azul.

14,2 x Ø0,8 cm 50 1000

A(4), W

-500	+500	+2000	+5000
0,210 €	0,200 €	0,190 €	0,180 €



01 03 60 05 226 29



251

29

sagano



BAMBOO

SAGANO_ 8031

Bolígrafo con pulsador realizado en bambú. Carga jumbo de tinta azul.

14 x Ø1,3 cm 50 1000

A(4), L1

-500	+500	+2000	+5000
0,610 €	0,590 €	0,570 €	0,550 €



MERLIN8009



TAIGA8007



CONWI8076



01 03 31 60 05 242 114 226 02 40

MERLIN_ 8009

Bolígrafo de ABS con pulsador y suave agarre. Tinta azul.

14 x Ø1,3 cm 50 1000

A(4)

-500	+500	+2000	+5000
0,192 €	0,186 €	0,180 €	0,170 €



01 03 31 60 05 226 02 40

TAIGA_ 8007

Bolígrafo giratorio en ABS con puntero táctil. Acabado sólido. Tinta azul.

14 x Ø1,3 cm 50 1000

A(4)

-500	+500	+2000	+5000
0,210 €	0,200 €	0,194 €	0,190 €



01 03 31 60 05 226 02 40

CONWI_ 8076

Bolígrafo con cuerpo de ABS plateado y suave agarre de color translúcido. Tinta negra.

14 x Ø1,3 cm 50 1000

A(4)

-500	+500	+2000	+5000
0,220 €	0,210 €	0,200 €	0,190 €



fibra trigo



LIKA8025

GORBEA8028



WHEAT FIBER

LIKA_ 8025

Bolígrafo giratorio de fibra de trigo y PP con acabados en negro. Tinta azul.

14 x Ø1,3 cm 50 1000

A(4)

-500	+500	+2000	+5000
0,280 €	0,270 €	0,250 €	0,240 €



WHEAT FIBER

GORBEA_ 8028

Bolígrafo con pulsador de fibra de trigo y ABS. Tinta azul.

14 x Ø1,3 cm 50 1000

A(4)

-500	+500	+2000	+5000
0,210 €	0,200 €	0,190 €	0,180 €

+ antibacterial

ISO 22196

* Material tratado con Iones de Plata que evita la ploriferación de las bacterias.



NEWTON8038

CARREL8039

FARBER8022

WRITING & OFFICE



antibacterial ISO 22196

NEWTON_ 8038

Bolígrafo con cuerpo de ABS anti-bacterias y tinta azul. Norma ISO 22196:2011.

14 x Ø1,3 cm 50 1000

A(4)

-500	+500	+2000	+5000
0,220 €	0,210 €	0,200 €	0,190 €



03 31 60 05 226 02



antibacterial ISO 22196

CARREL_ 8039

Bolígrafo con cuerpo de ABS anti-bacterias y suave agarre de color translúcido. Tinta azul. Norma ISO 22196:2011.

14 x Ø1,3 cm 50 1000

A(4)

-500	+500	+2000	+5000
0,240 €	0,230 €	0,220 €	0,210 €



antibacterial ISO 22196



TOUCH PEN



01 60 05 02

FARBER_ 8022

Bolígrafo higienizante anti-bacterias multifunción, con pulverizador recargable y puntero táctil. 3 ml de capacidad (líquido no incluido). Tinta azul.

16 x Ø1,5 cm 50 1000

B(4)

-500	+500	+2000	+5000
0,720 €	0,680 €	0,660 €	0,620 €



natural bamboo



LÁPIZ

KIOTO_8036

Set de bolígrafo y portaminas en bambú, con mecanismo pulsador y tinta azul. Presentación en caja de cartón efecto madera.

17 x 2,2 x 4,1 cm 20 200

C(4), D(4), L1

-500	+500	+2000	+5000
1,02 €	0,990 €	0,960 €	0,920 €



2929 3129 0329 6029 24229 11429

STOA_8034

Bolígrafo pulsador con cuerpo de bambú y accesorios en fibra de trigo / ABS. Tinta azul.

14,1 x Ø1 cm 50 1000

B(4), L1

-500	+500	+2000	+5000
0,270 €	0,260 €	0,250 €	0,240 €

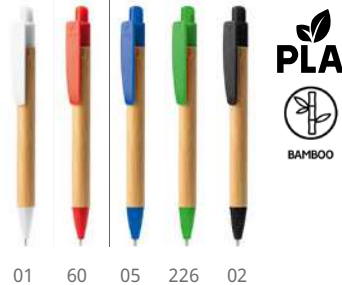

01 60 05 226 02

GILDON_8080

Bolígrafo con cuerpo de bambú y PLA. Tinta azul.

14 x Ø1 cm 50 1000

B(4), L1

-500	+500	+2000	+5000
0,390 €	0,370 €	0,360 €	0,340 €



natural bamboo

TUCUMA8018

PAMPA8019

NAGOYA8084

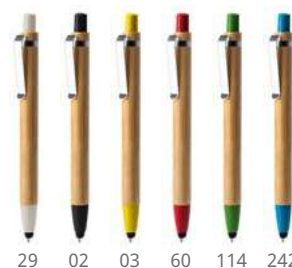

TUCUMA_ 8018

Bolígrafo de bambú natural con accesorios de diseño, en acabado plateado y tinta azul.

13,9 x Ø1,1 cm 50 1000
B(4), L1

-500	+500	+2000	+5000
0,430 €	0,410 €	0,390 €	0,370 €

PAMPA_ 8019

Bolígrafo de bambú natural con clip metálico, puntero táctil y carga jumbo de tinta azul.

14,8 x Ø1 cm 50 1000
B(4), L1

-500	+500	+2000	+5000
0,500 €	0,480 €	0,470 €	0,450 €

NAGOYA_ 8084

Bolígrafo pulsador con cuerpo de bambú, accesorios en fibra de trigo y clip metálico. Incluye puntero táctil. Tinta azul.

14 x Ø1,5 cm 50 1000
B(4), L1

-500	+500	+2000	+5000
0,430 €	0,420 €	0,400 €	0,390 €



NATURAL
CORK

ARTUR_ 8044

Elegante bolígrafo metálico con acabado cromado y empuñadura de corcho. Presentación en estuche de corcho. Carga jumbo metálica de tinta azul.

13,9 x Ø1,1 cm 1 200

D(1), L1

-500	+500	+2000	+5000
8,60 €	8,30 €	7,96 €	7,60 €



artur



LAURISILVA8026



JADE8027



fibra **trigo**



WHEAT
FIBER

LAURISILVA_ 8026

Bolígrafo con pulsador de fibra de trigo y ABS. Clip ancho especial para marcaje y función soporte. Tinta azul.

15 x Ø1,1 cm 50 1000

A(4)

-500	+500	+2000	+5000
0,330 €	0,300 €	0,260 €	0,230 €



WHEAT
FIBER

JADE_ 8027

Bolígrafo con pulsador de fibra de trigo y ABS. Clip ancho especial para marcaje. Tinta azul.

13,6 x Ø1 cm 50 1000

A(4)

-500	+500	+2000	+5000
0,178 €	0,168 €	0,158 €	0,150 €



mismo diseño
otra conciencia



fibra **trigo**



HANA8032



ONTARIO8008

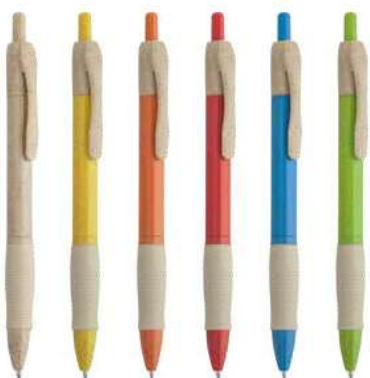

29 03 31 60 242 114



01 03 31 60 05 242 226 02 40



HANA_ 8032 

Bolígrafo pulsador de fibra de trigo y ABS con cómoda empuñadura. Tinta azul.

 14,5 x Ø1 cm  50  1000

 A(4)

-500	+500	+2000	+5000
0,118 €	0,112 €	0,106 €	0,100 €

ONTARIO_ 8008 

Bolígrafo con pulsador en acabado translúcido y cómoda empuñadura a juego. Tinta azul.

 14,5 x Ø1 cm  50  1000

 A(4)

-500	+500	+2000	+5000
0,120 €	0,117 €	0,114 €	0,110 €

estilo y color



DORMITUR8012



IRATI8011





SEMENIC8006



60 05 251 02

DORMITUR_ 8012

Bolígrafo giratorio de ABS en acabado metalizado. Tinta azul.

 15 x Ø1,1 cm  50  1000

 A(4)



-500	+500	+2000	+5000
0,290 €	0,280 €	0,260 €	0,250 €



0201 0203 0231 0260 0205 02226

IRATI_ 8011

Bolígrafo giratorio de ABS en acabado brillo bicolor. Tinta azul.

 14,5 x Ø1 cm  50  1000

 A(4)

-500	+500	+2000	+5000
0,216 €	0,210 €	0,196 €	0,186 €





31 60 05 226 251 02

SEMENIC_ 8006



Bolígrafo giratorio en ABS con puntero táctil. Acabado metalizado. Tinta azul.

 13,5 x Ø1 cm  50  1000

 A(4)

-500	+500	+2000	+5000
0,220 €	0,210 €	0,200 €	0,189 €



ROLLER pens



01 03 60 05 02

JAVARI_ 8016

Bolígrafo tipo roller con cuerpo de ABS y agarre acolchado. Clip y punta metálicos. Carga jumbo de tinta azul.

 14,1 x Ø1,2 cm  50  500

 A(4)

-500	+500	+2000	+5000
0,610 €	0,580 €	0,560 €	0,540 €



01 03 60 05 226 02

COLOMA_ 8017

Bolígrafo tipo roller con cuerpo en ABS de tácto suave. Clip y punta metálicos. Carga jumbo de tinta azul.

 14,3 x Ø1,1 cm  50  1000

 A(4)

-500	+500	+2000	+5000
0,530 €	0,500 €	0,480 €	0,460 €



01 03 60 05 02

YAMA_ 8021

Bolígrafo tipo roller con clip metálico, detalles en acabado plata y carga jumbo de tinta azul.

 13,5 x Ø1,1 cm  50  1000

 A(4)

-500	+500	+2000	+5000
0,540 €	0,520 €	0,500 €	0,480 €



new kruger



new.

01 260 B1 60 05



242 226 251 02 40



KRUGER_ 8090

Bolígrafo con cuerpo de aluminio y pulsador en acabado anodizado. Puntero táctil y carga Jumbo de tinta azul.

13,9 x Ø1 cm 50 500

B(4), L1

-500	+500	+2000	+5000
0,440 €	0,430 €	0,400 €	0,390 €



BORNEO8014

CANAIMA8004

BAUME8005



01 03 60 05 226 02

BORNEO_ 8014

Bolígrafo metálico con pulsador, puntero táctil y clip de diseño. Carga jumbo de tinta azul.

14,8 x Ø1 cm 50 500

B(4), L1

-500	+500	+2000	+5000
0,590 €	0,550 €	0,520 €	0,490 €



01 03 31 60 05 226 02 40

CANAIMA_ 8004

Bolígrafo giratorio de aluminio con puntero táctil. Tinta azul.

12,5 x Ø0,9 cm 100 1000

B(4), L1

-500	+500	+2000	+5000
0,450 €	0,430 €	0,420 €	0,400 €



01 03 31 60 05 226 251 02

BAUME_ 8005

Bolígrafo giratorio de aluminio con puntero táctil en color a juego con el cuerpo. Tinta azul.

13,7 x Ø0,7 cm 100 1000

B(4), L1

-500	+500	+2000	+5000
0,430 €	0,410 €	0,390 €	0,380 €

ARDENES8013



NORFOLK8078

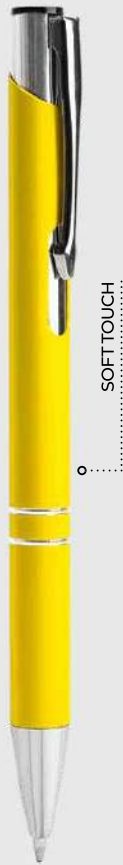

HAYEDO8030



HALLERBOS8015



WRITING & OFFICE



* Material tratado con Iones de Plata que evita la ploriferación de las bacterias.



01 60 05 226 251 02

ARDENES_ 8013

Bolígrafo con cuerpo de aluminio y pulsador en acabado anodizado. Carga jumbo de tinta azul.

13,7 x Ø1 cm 50 500

B(4), L1

-500	+500	+2000	+5000
0,370 €	0,360 €	0,350 €	0,330 €



01 03 60 05 226 02

NORFOLK_ 8078

Bolígrafo con cuerpo metálico de tacto suave y pulsador en acabado anodizado. Punta, clip y detalles en metal cromado. Carga jumbo de tinta negra.

13,6 x Ø1 cm 50 500

B(4), L1

-500	+500	+2000	+5000
0,410 €	0,390 €	0,380 €	0,370 €



03 31 60 242 114 29

HAYEDO_ 8030

Bolígrafo pulsador de fibra de trigo y ABS con acabados plateados. Tinta azul.

14,1 x Ø1 cm 50 1000

A(4)

-500	+500	+2000	+5000
0,310 €	0,300 €	0,290 €	0,270 €



HALLERBOS_ 8015

Bolígrafo con cuerpo de ABS anti-bacterias, puntero táctil, clip metálico y carga jumbo de tinta azul. Norma ISO 22196.

13,9 x Ø1 cm 50 1000

A(4)

-500	+500	+2000	+5000
0,390 €	0,380 €	0,360 €	0,350 €

100% RPET

Hechos a partir de plásticos reciclados

ARAL8037

ARASHI8048

PACIFIC8033



ARAL_ 8037

Bolígrafo de diseño translúcido realizado a partir de material RPET. Mecanismo pulsador. Tinta azul.

 14,1 x Ø1 cm  50  1000

 A(4)

-500	+500	+2000	+5000
0,350 €	0,340 €	0,330 €	0,320 €

ARASHI_ 8048

Bolígrafo marcador 2 en 1 con diseño translúcido, realizado a partir de material RPET. Bolígrafo de tinta azul. Marcador en colores fluor.

 14,6 x Ø1,3 cm  50  1000

 A(4)

-500	+500	+2000	+5000
0,530 €	0,520 €	0,510 €	0,500 €

PACIFIC_ 8033

Bolígrafo de diseño translúcido realizado a partir de material RPET. Mecanismo pulsador. Tinta azul.

 14,2 x Ø1,1 cm  50  1000

 A(4)

-500	+500	+2000	+5000
0,340 €	0,330 €	0,320 €	0,310 €

algodón reciclado



226



29

60



05

02



REMO_7562

Neceser multiusos en algodón reciclado con cremallera y tirador a juego.

21 x 12 x 3 cm 50 300

E(1),N(8),O

-500	+500	+2000	+5000
1,14 €	1,10 €	1,04 €	1,00 €



NATURAL
CORK

VESPULA_7546

Estuche de corcho natural con forro interior de poliéster y cremallera.

23 x 11 x 2 cm 50 200

E(1), L2

-500	+500	+2000	+5000
1,75 €	1,68 €	1,61 €	1,54 €



226



60

31

05



03

01

02

COLINA_7559

Estuche de acabado en colores lisos con cremallera a juego. Realizado en poliéster 600D.

22 x 11 cm 20 400

E(1), N(8), O

-500	+500	+2000	+5000
0,600 €	0,580 €	0,560 €	0,540 €

multi herramienta



01 60 05 251 02

KANCHAN_ 8024

Bolígrafo multiherramientas 4 en 1: nivel, regla en centímetros y pulgadas, destornillador con cabeza plana y estrella. Cuerpo con acabado metalizado, mecanismo giratorio y clip metálico. Tinta azul.

 14,9 x Ø1 cm  50  1000

 B(4)

-500	+500	+2000	+5000
0,860 €	0,820 €	0,780 €	0,750 €

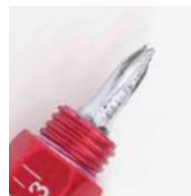
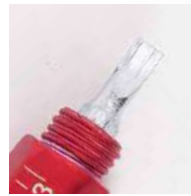

251 02 60 05

ARAYA_ 8023

Bolígrafo linterna de luz LED con cuerpo de ABS metalizado. Mosquetón integrado en la capucha. Tinta azul.

 11 x Ø1 cm  50  500

 B(4)

-500	+500	+2000	+5000
0,670 €	0,640 €	0,610 €	0,570 €

lápiz carpintero



VETA_ 8088

Lápiz de carpintero en forma ovalada para un fácil marcaje. Punta sin afilar.

17,6 x 1,2 cm 100 1000

A(4)

-500	+500	+2000	+5000
0,166 €	0,156 €	0,146 €	0,136 €



29 05 60 02

MATA_ 8003

Mini lápiz de madera en acabado natural con goma. Cuerpo redondo.

10 x Ø0,5 cm 100 2000

A(4)

-500	+500	+2000	+5000
0,034 €	0,033 €	0,032 €	0,031 €

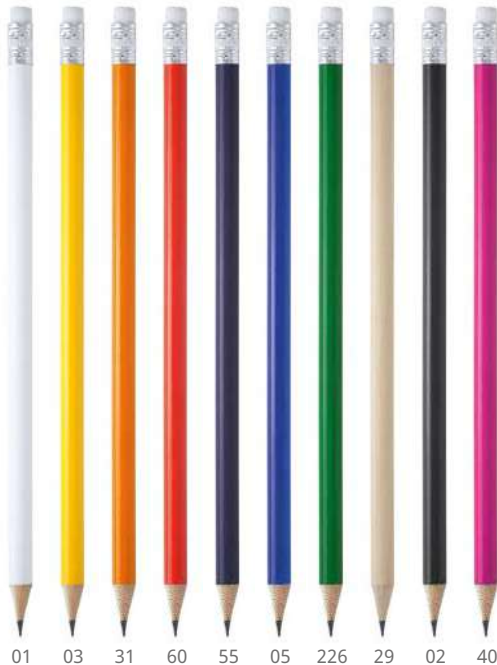

01 03 31 60 55 05 226 29 02 40

COUVET_ 8002

Lápiz redondo de madera con goma.

18,6 x Ø0,7 cm 100 2000

A(4), L1

-500	+500	+2000	+5000
0,044 €	0,043 €	0,041 €	0,039 €



+ antibacterial

ISO 22196

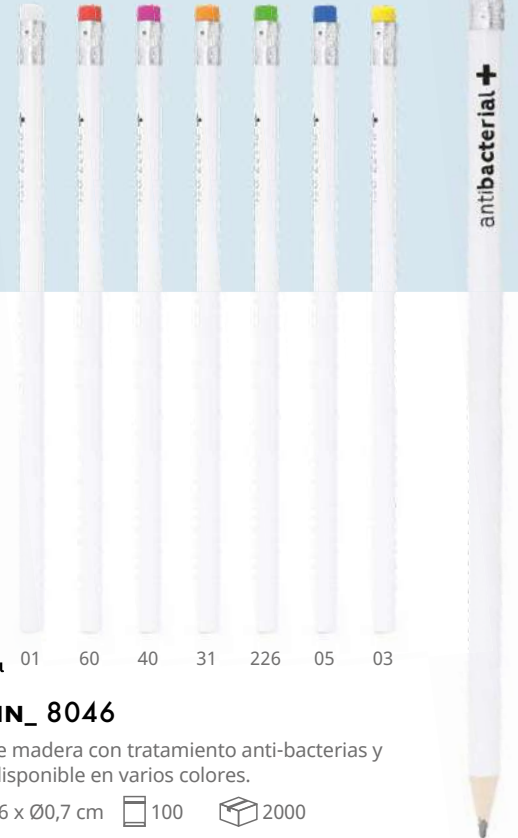

GRYFIN_ 8046

Lápiz de madera con tratamiento anti-bacterias y goma disponible en varios colores.

18,6 x Ø0,7 cm 100 2000

A(4)

-500	+500	+2000	+5000
0,106 €	0,094 €	0,090 €	0,086 €

* Material tratado con Iones de Plata que evita la proliferación de las bacterias.

new.



60 226



05 03



MABEL_ 8089

Set de 6 lápices de madera en estuche de cartón reciclado y capucha translúcida de color. Incluye sacapuntas integrado en la capucha.

10,2 x Ø2,7 cm 50 400

B(4), W

-500	+500	+2000	+5000
0,410 €	0,400 €	0,370 €	0,360 €



AMAZONIA_ 8001

Set de 6 lápices de madera en caja de cartón reciclado.

4,5 x 9 x 0,8 cm 25 500

B(4), W

-500	+500	+2000	+5000
0,198 €	0,194 €	0,188 €	0,178 €



BOREAL_ 8000

Set de 6 ceras en caja de cartón reciclado.

5 x 8,3 x 0,8 cm 50 400

B(4), W

-500	+500	+2000	+5000
0,250 €	0,240 €	0,230 €	0,220 €

new.

new **vernak**



VERNAK_ 8087

Set de escritura de madera natural presentado en estuche de cartón kraft. Incluye regla, 3 lápices, 1 goma de borrar y 1 sacapuntas.

17,7 x 1,3 x 4,5 cm 20 240

B(4), W

-500	+500	+2000	+5000
0,880 €	0,830 €	0,800 €	0,760 €



05



60



03



226

LIZANA_ 8064

Set de 5 piezas presentadas en estuche de cartón kraft. Incluye bolígrafo con cuerpo de cartón y tinta azul, lápiz de madera, sacapuntas, goma y regla de 15 cm.

17,7 x 1,5 x 4,5 cm 50 400

B(4), W

-500	+500	+2000	+5000
0,770 €	0,750 €	0,720 €	0,690 €

Set de láminas para colorear

Deja a los más peques volar coloreando las ilustraciones que hemos seleccionado para ellos.



TILOS_ 8049

Set infantil para colorear. Incluye bloc con dibujos, 6 lápices de colores y sacapuntas. Presentación en caja de cartón reciclado.

7,4 x 1,5 x 9 cm 50 400
C(4), W

-500	+500	+2000	+5000
0,430 €	0,410 €	0,400 €	0,380 €

new.

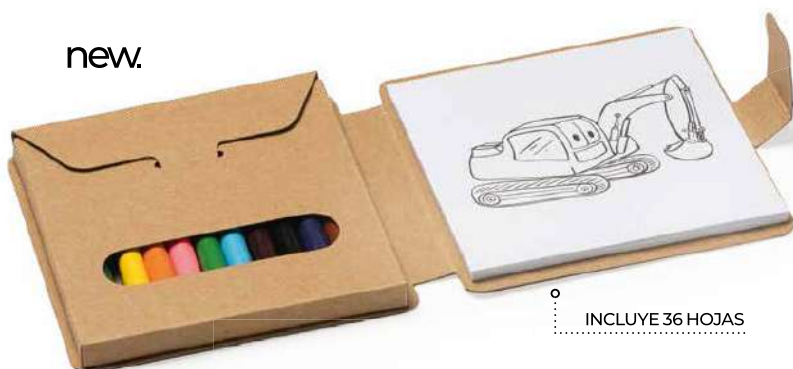

INCLUYE 36 HOJAS



PYRUS_ 8077

Set infantil para colorear. Incluye bloc con dibujos variados. 12 lápices de colores.

10 x 1 x 9,5 cm 50 200
C(4)

-500	+500	+2000	+5000
1,98 €	1,94 €	1,82 €	1,72 €

new.



INCLUYE 20 LÁMINAS



RESOL_ 8069

Set infantil para colorear. Incluye bloc con dibujos variados, 6 lápices de colores, sacapuntas y goma de borrar. Práctica asa de transporte.

20 x 21 x 1,6 cm 40 80
D(1)

-500	+500	+2000	+5000
2,58 €	2,54 €	2,42 €	2,32 €



newresol



BOSCO_ 8063

Bloc de notas de diseño clásico con tapas de cartón reciclado. 200 hojas blancas. 125 notas adhesivas de distintos colores incluidas.

8,1 x 2,6 x 8,3 cm 50 100

D(2), W

-500	+500	+2000	+5000
1,18 €	1,14 €	1,09 €	1,05 €



INNIS_ 8056

Original portanotas de cartón reciclado con 100 notas adhesivas en 5 colores variados.

5,4 x 8,2 x 0,3 cm 100 500

C(4)

-500	+500	+2000	+5000
0,146 €	0,140 €	0,136 €	0,130 €



ANFI_ 8057

Portanotas de anillas con original diseño en forma de bocadillo. Tapas rígidas de cartón reciclado. Incluye notas adhesivas en colores variados de dos tamaños: 100 grandes y 125 pequeñas.

8,3 x 10,7 x 2,3 cm 50 100

D(4)

-500	+500	+2000	+5000
0,910 €	0,870 €	0,830 €	0,790 €



29



01

DIMAS_ 8062

Set de escritorio de cartón en forma de cubo compuesto por lapicero, bloc de notas (250 hojas) y 180 notas adhesivas en varios colores.

9 x 9 x 9 cm 1 40

D(2), W

-500	+500	+2000	+5000
3,95 €	3,65 €	3,35 €	3,05 €

cubiertas en papel plantable

Reciclables, degradables y cultivable

new.



new.



GARO_ 8085

Bloc de notas con cubiertas de papel reciclable y degradable con semillas. Incluye 50 hojas de papel reciclado.

10 x 7,2 cm 100 200

D(1)

-500	+500	+2000	+5000
1,56 €	1,50 €	1,44 €	1,38 €

SAGRA_ 8086

Libreta A6 con cubiertas de papel reciclable y degradable con semillas. 40 hojas papel a una raya. Presentación en funda de papel kraft.

15 x 10,7 cm 100 200

E(1)

-500	+500	+2000	+5000
1,78 €	1,70 €	1,64 €	1,58 €



DANICA8053

SALER8055



DANICA_ 8053

Libreta tamaño A5 de cartón reciclado. 60 hojas.

14,5 x 21 x 0,8 cm 10 100

E(1)

-500	+500	+2000	+5000
0,560 €	0,550 €	0,540 €	0,530 €



SALER_ 8055

Libreta tamaño A6 de cartón reciclado. 60 hojas.

10,5 x 14,5 x 0,8 cm 20 200

E(1)

-500	+500	+2000	+5000
0,410 €	0,400 €	0,390 €	0,360 €

set bambú



BAMBOO

GALA_ 8082

Set libreta y bolígrafo de bambú presentados en estuche eco. Libreta con tapas rígidas, 80 hojas de papel reciclado a una raya. Bolígrafo con detalles cromados y tinta azul.

 22 x 24 x 2,2 cm  20

 40

 E(1), B(1)

-500	+500	+2000	+5000
6,56 €	6,30 €	6,06 €	5,80 €

corcho natural



NATURAL CORK

ROBIN_ 8081

Bloc de notas A5 con tapas rígidas de corcho y algodón. 80 hojas lisas. Incluye soporte con bolígrafo de corcho y fibra de trigo a juego. Tinta negra.

15,2 x 21 x 1,4 cm

25

50

E(1), B(1)

-500	+500	+2000	+5000
3,22 €	3,12 €	2,96 €	2,86 €

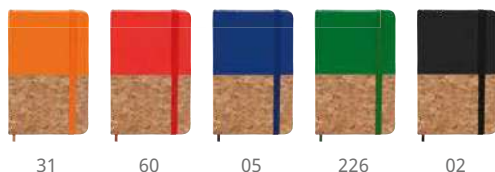

31

60

05

226

02



NATURAL CORK

IRIS_ 8071

Bloc de notas tamaño A6. Tapa rígida en corcho y polipiel. Marcapáginas y banda elástica. 80 hojas.

9,3 x 14,3 x 1,5 cm

50

100

E(4), L2

-500	+500	+2000	+5000
1,15 €	1,10 €	1,07 €	1,03 €



NATURAL CORK

CALES_ 8072

Bloc de notas tamaño A6 con tapa rígida de corcho natural. Marcapáginas y banda elástica. 80 hojas.

8,9 x 14 x 1,4 cm

50

100

E(4), L2

-500	+500	+2000	+5000
0,990 €	0,960 €	0,930 €	0,880 €





CORAL_8051

Bloc de notas tamaño A6 con tapa rígida de polipiel. Marcapáginas y banda elástica. 100 hojas.

9,3 x 14,3 x 1,5 cm

50

100

E(4), T

-500	+500	+2000	+5000
0,900 €	0,860 €	0,830 €	0,790 €

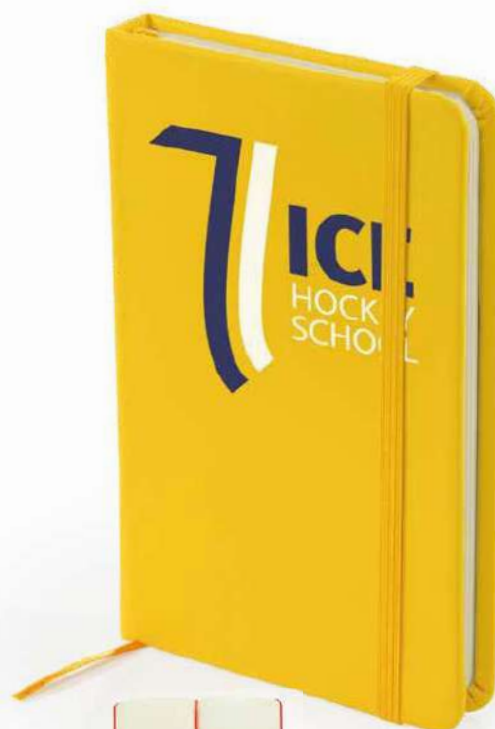

ALBA_8050

Bloc de notas tamaño A5 con tapa rígida de polipiel. Marcapáginas y banda elástica. 100 hojas.

14,7 x 21 x 1,5 cm

25

50

E(4), T

-500	+500	+2000	+5000
1,55 €	1,49 €	1,44 €	1,40 €

+ antibacterial

ISO 22196

* Material tratado con Iones de Plata que evita la ploriferación de las bacterias.

ELION_8061

Bloc de notas tamaño A6. Cubiertas de PU con tecnología anti-bacteriana. Marcapáginas y banda elástica. 80 hojas. Norma ISO 22196.

9 x 14 x 1,4 cm

50

100

E(4)

-500	+500	+2000	+5000
2,10 €	2,00 €	1,90 €	1,80 €



WATSON_8060

Bloc de notas tamaño A5. Cubiertas de PU con tecnología anti-bacteriana. Marcapáginas y banda elástica. 100 hojas. Norma ISO 22196.

14,9 x 21 x 1,4 cm

25

50

E(4)

-500	+500	+2000	+5000
2,70 €	2,60 €	2,50 €	2,40 €

ELION8061

WATSON8060

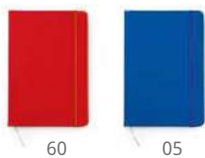

new.

newardak



ARDAK_ 8091

Bloc de notas A5 con tapa rígida de polipiel. Marca páginas y banda elástica. 100 hojas a una raya.

14,7 x 1,5 x 21 cm

25

50

E(4), T

-500	+500	+2000	+5000
2,20 €	2,10 €	1,98 €	1,92 €



ESTELA_ 8070

Bloc de notas tamaño A5 con tapa rígida de cartón reciclado. Marcapáginas y banda elástica a color. 100 hojas.

14,7 x 21 x 1,5 cm

25

50

E(4)

-500	+500	+2000	+5000
1,61 €	1,56 €	1,52 €	1,45 €

libretas de cartón



29 60 05 02



VALLE_8052

Libreta con espiral y hojas de papel a rayas microperforadas. Tapa rígida de cartón reciclado. 80 hojas.

16,4 x 21,7 x 1,6 cm 25 50

E(4)

-500	+500	+2000	+5000
1,79 €	1,71 €	1,63 €	1,56 €



31 60 05 226 02



ALANI_8073

Libreta con espiral y tapa rígida de cartón reciclado. Bolígrafo a juego con tinta azul incluido. 60 hojas.

16,5 x 21 x 1 cm 20 80

E(4)

-500	+500	+2000	+5000
1,15 €	1,11 €	1,07 €	1,02 €

mini libretas

bolígrafo incluido

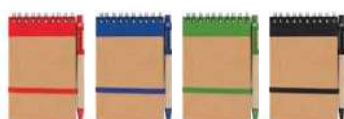

60 05 226 02



01 31 60 05 02

LIEN_8074

Libreta con espiral y tapa rígida de cartón reciclado. Bolígrafo a juego con tinta azul incluido. 70 hojas.

9,7 x 14,4 x 1 cm 50 100

D(4), B(4)

-500	+500	+2000	+5000
0,660 €	0,640 €	0,620 €	0,590 €

ARCO_8054

Mini libreta con espiral y tapa rígida de PP. 60 hojas de papel a rayas. Bolígrafo de tinta azul incluido.

7 x 9,5 x 0,7 cm 50 300

D(4), B(4)

-500	+500	+2000	+5000
0,710 €	0,690 €	0,660 €	0,630 €

calendarios perpetuos



FENIX_8020

Calendario de mesa perpetuo realizado en PP con espacio ideal para marcaje en tampografía.

14 x 4 cm 50 300
D(2)

-500	+500	+2000	+5000
0,720 €	0,700 €	0,680 €	0,660 €

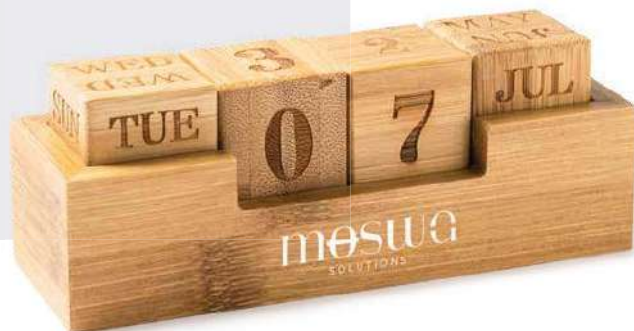

BAMBOO

MEDUS_1002

Calendario perpetuo de sobremesa realizado en bambú, formado por soporte y cuatro bloques grabados. Presentación en caja eco.

13,6 x 4,9 x 4,6 cm 20 100
D(1), L2

-500	+500	+2000	+5000
7,90 €	7,70 €	7,50 €	7,30 €

alfombrilla calendario



05 226 01

SERBAL_3017

Alfombrilla para ratón con calendario 2023. Cubierta de PVC translúcida, hojas extraíbles con espacio para notas. Base antideslizante.

23 x 18 x 0,4 cm 50 100
E(4)

Consultar Precio

agendas y calendarios 2023



FLINT_ 8066

Calendario de sobremesa horizontal con anillas. Diseño mes en curso / mes anterior / mes siguiente / Calendario anual. Incluye santoral. Cuerpo de cartón ideal para marcar.

22 x 13,8 x 6 cm 50 200

E(4)

[Consultar Precio](#)



DEAN_ 8065

Calendario de sobremesa vertical con anillas. Diseño mes en curso / mes anterior / mes siguiente / Calendario anual. Incluye santoral. Cuerpo de cartón ideal para marcar.

10,8 x 13,8 x 6 cm 50 400

E(4)

[Consultar Precio](#)



GLEN_ 8067

Calendario imantado con hojas removibles. Diseño mes en curso. Gran superficie de marcaje.

10 x 19 cm 25 400

B(1)

[Consultar Precio](#)



60 05 226 01 02

HERA_ 8068

Agenda con anillas tamaño A5. Tapas de PU acolchadas con grabado bajo relieve. 352 páginas. Diseño página día con esquinas troqueladas.

15,8 x 21 x 2,4 cm 1 20

E(1), T, U

[Consultar Precio](#)

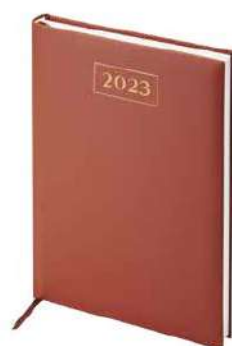

55 02 450

SELKIS_ 8083

Agenda con cubierta de PU acolchada grabada en bajo relieve. 320 páginas en color beige más 4 páginas con mapas. Marcapáginas a juego con la cubierta. Presentación en caja blanca.

17,6 x 24,5 x 2,1 cm 1 20

E(1), T, U

[Consultar Precio](#)



60 05 55 226 02

HORUS_ 8059

Agenda tamaño A5 con cubierta de PU acolchada grabada en bajo relieve. 320 páginas más 4 páginas con mapas. Marcapáginas a juego con la cubierta.

15 x 21 cm 1 20

E(1), T, U

[Consultar Precio](#)



BAGS &
TRAVEL



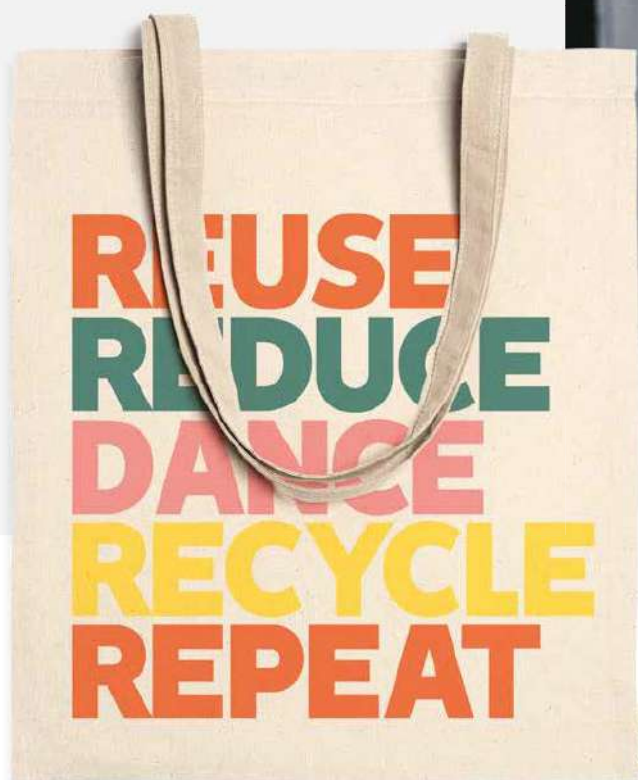

BERNA_ 7156

Bolsa 100% algodón orgánico de 120 g/m² con asas largas reforzadas de 70 cm.

38 x 42 cm 50 200

F(4),N(8),O,P

-500	+500	+2000	+5000
1,83 €	1,76 €	1,69 €	1,62 €

organic cotton

new.



GRETA_ 7167

Bolsa 100% algodón orgánico de 300 g/m² con prácticas asas largas de 70 cm.

40 x 40 cm 10 100

F(4), N(8), P

-500	+500	+2000	+5000
2,92 €	2,84 €	2,77 €	2,70 €



120 g/m²**NARBONA_ 7159**

Bolsa 100% algodón orgánico de 120 g/m² con fuelle y asas cortas reforzadas de 35 cm.

40 x 40 x 10 cm 20 200

F(4), N(8), P

-500	+500	+2000	+5000
2,42 €	2,38 €	2,28 €	2,20 €



organiccotton

new.

280 g/m²**KENSAL_ 7168**

Bolsa 100% algodón orgánico de 280 g/m² con fuelle y prácticas asas largas de 70 cm.

38 x 42 x 9 cm 10 100

F(4), N(8), P, O

-500	+500	+2000	+5000
2,86 €	2,98 €	2,92 €	2,84 €

recycled cotton



60

05

226

29

02



RIVOLI_7162

Bolsa realizada en algodón reciclado de 120 g/m² en acabado jaspeado con asas largas de 70 cm.

 38 x 42 cm

 50

 200

 F(4), N(8)

-500

+500

+2000

+5000

1,44 €

1,38 €

1,32 €

1,26 €



01

03

31

60



05

226

02

40

**KNOLL_7521**

Bolsa de la compra cosida 100% algodón a color de 105 g/m², con prácticas asas largas reforzadas de 70 cm.

37 x 41 cm

50

250

F(4), N(8), P

-500	+500	+2000	+5000
1,12 €	1,09 €	1,06 €	1,03 €



100% algodón



01

03

31

60



05

226

02

78

**MOUNTAIN_7602**

Bolsa de la compra en 100% algodón de 140 g/m² a color, con asas largas de 70 cm.

37 x 41 cm

20

200

F(4), N(8), P

-500	+500	+2000	+5000
1,36 €	1,32 €	1,28 €	1,24 €

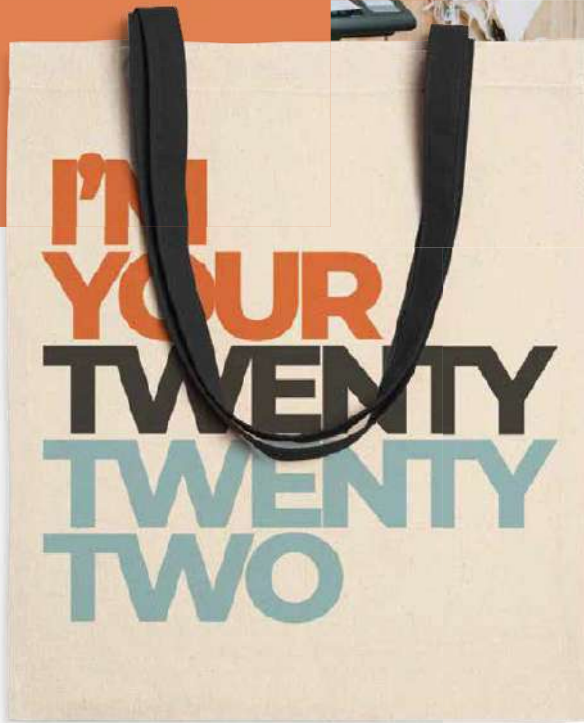

NIZA_ 7160 100 g/m²
 Bolsa 100% de algodón 100 g/m². Asas largas de 70 cm a color.

37 x 41 cm 50 200
 F(4), N(8), P

-500	+500	+2000	+5000
1,03 €	0,990 €	0,970 €	0,950 €

HILLOCK_ 7520 105 g/m²
 Bolsa de la compra cosida 100% algodón de 105 g/m², con prácticas asas largas reforzadas de 70 cm.

37 x 41 cm 50 250
 F(4), N(8), P

-500	+500	+2000	+5000
0,850 €	0,810 €	0,770 €	0,730 €

HILL_ 7601 140 g/m²
 Bolsa de la compra realizada en 100% algodón de 140 g/m², con asas largas de 70 cm.

37 x 41 cm 20 200
 F(4), N(8), P

-500	+500	+2000	+5000
1,06 €	1,03 €	0,990 €	0,950 €

ZENITH_ 7551 180 g/m²
 Bolsa de la compra cosida en 100% algodón de 180 g/m², con prácticas asas largas reforzadas de 70 cm.

41 x 37 cm 50 150
 F(4), N(8), P, O

-500	+500	+2000	+5000
1,38 €	1,34 €	1,30 €	1,26 €

100% natural algodón



100% algodón



105 g/m²

BAGUETTE_ 7519

Bolsa cosida 100% algodón de 105 g/m², con clásico formato para el pan. Cierre de cordón grueso.

20 x 58 cm 10 500

F(4), N(8)

-500	+500	+2000	+5000
0,810 €	0,780 €	0,760 €	0,730 €



105 g/m²

DUNE_ 7525

Bolsa de la compra plegable 100% algodón de 105 g/m², con asas largas de 70 cm y cordón para plegado ajustable.

37 x 41 cm 10 200

F(4), G(4), N(8)

-500	+500	+2000	+5000
1,61 €	1,53 €	1,47 €	1,39 €

100% algodón



SOIL_7554 120 g/m²

Bolsa de algodón de 120 g/m² con un lado en diseño liso y otro lado en diseño rejilla. Cierre de cordón ajustable.

30 x 25 cm 50 250
 F(4), N(8)

-500	+500	+2000	+5000
1,08 €	1,04 €	1,00 €	0,960 €



ARDEA_7552 105 g/m²

Bolsa estilo saco en algodón de 105 g/m² con auto-cierre de cordones.

15 x 21 cm 50 500
 F(4), N(8)

-500	+500	+2000	+5000
0,630 €	0,610 €	0,580 €	0,550 €



LEAF_7553 180 g/m²

Bolsa de la compra realizada en algodón de 180 g/m² con acabado liso y rejilla. Asas reforzadas de 60 cm.

45 x 42 cm 10 100
 F(4), N(8)

-500	+500	+2000	+5000
3,30 €	3,16 €	3,00 €	2,90 €

new venice



new.

VENICE_ 7161

Bolsa nevera de yute laminado. Interior isotérmico de aluminio con cierre de velcro. Bolsillo frontal y asas en algodón natural.

43 x 20 x 34 cm 10 40

F(1)

-500	+500	+2000	+5000
7,90 €	7,70 €	7,46 €	7,20 €

jute bags



FLAY_ 7164

Bolsa estilo saco de yute natural. Cierre con cordones de algodón.

25 x 32 cm 20 200

F(1),N(8)

-500	+500	+2000	+5000
1,44 €	1,40 €	1,34 €	1,28 €

PARMA_ 7163

Bolsa estilo saco de yute natural. Cierre con cordones de algodón.

14 x 22 cm 20 400

F(1),N(8)

-500	+500	+2000	+5000
1,04 €	1,00 €	0,960 €	0,920 €

new.

nantes



NANTES_ 7110

Bolsa de yute laminado con una cara de algodón ideal para marcaje y asas largas.

40 x 16 x 32 cm 10 50

F(4)

-500	+500	+2000	+5000
3,90 €	3,70 €	3,54 €	3,38 €



29

60

05

226



WAVE_ 7556

Bolsa de la compra realizada en algodón de 120 g/m² y yute, con prácticas asas reforzadas de 70 cm.

41 x 37 cm 10 200

F(6), N(8), P

-500	+500	+2000	+5000
1,70 €	1,63 €	1,56 €	1,49 €



new.

GAVIA_ 7099

Bolsa de yute laminado con bolsillo frontal y asas largas en algodón natural.

48 x 15 x 35 cm 10 80

F(1)

-500	+500	+2000	+5000
3,76 €	3,60 €	3,40 €	3,30 €

**STERNA_ 7555**

Bolsa de yute natural con asas en algodón de 70 cm.

44,5 x 35 x 14 cm

5

60

F(1)

-500	+500	+2000	+5000
3,78 €	3,62 €	3,48 €	3,32 €

jutebags

KOPER_ 7148

Bolsa de yute natural con ribetes y asas reforzadas de algodón. Acabado cosido

38 x 42 x 16 cm

10

50

F(1)

-500	+500	+2000	+5000
4,66 €	4,50 €	4,30 €	4,10 €



03

31

60

05

226

02

40

NIMES_ 7149

Bolsa de yute natural con asas reforzadas de algodón a color. Acabado cosido.

38 x 41 cm

10

80

F(1)

-500	+500	+2000	+5000
2,50 €	2,40 €	2,30 €	2,20 €

ASAS DE ALGODÓN

130 g/m²**MILVUS_ 7561**

Bolsa de resistente papel laminado con asas de algodón.

32 x 37,5 x 0,3 cm

1

250

F(1)

-500	+500	+2000	+5000
1,70 €	1,64 €	1,58 €	1,48 €



bolsas de papel

**PINUS_ 7123**Bolsa de papel de 100 g/m² en acabado natural. Asas cortas reforzadas de diseño rizado. Ideal para botellas.

12 x 36 x 10 cm

100

400

F(1)

-500	+500	+2000	+5000
0,350 €	0,340 €	0,330 €	0,320 €

OLMO_ 7122Bolsa de papel de 80 g/m² en acabado natural. Asas cortas reforzadas de diseño plano. Ideal para hostelería y restauración (take away).

30 x 29 x 20 cm

200

F(1)

-500	+500	+2000	+5000
0,330 €	0,320 €	0,310 €	0,300 €



29 01 60 55 02

MAPLE_7541

Bolsa de papel de 110 g/m². Asas cortas reforzadas de diseño rizado.

41 x 32 x 12 cm 200

F(1)

	-500	+500	+2000	+5000
Color 29	0,350 €	0,340 €	0,330 €	0,320 €
	0,420 €	0,410 €	0,400 €	0,390 €



29 01 60 55 02

ROBLE_7540

Bolsa de papel de 110 g/m². Asas cortas reforzadas de diseño rizado.

32 x 40 x 12 cm 200

F(1)

	-500	+500	+2000	+5000
Color 29	0,350 €	0,340 €	0,330 €	0,320 €
	0,420 €	0,410 €	0,400 €	0,390 €



29 01 60 55 56 02

HAYA_7539

Bolsa de papel de 110 g/m². Asas cortas reforzadas de diseño rizado.

22 x 23 x 9 cm 200

F(1)

	-500	+500	+2000	+5000
Color 29	0,250 €	0,246 €	0,240 €	0,230 €
	0,300 €	0,296 €	0,290 €	0,280 €



29 01 60 55 56 02

ARCE_7538

Bolsa de papel de 110 g/m². Asas cortas reforzadas de diseño rizado.

25 x 31 x 11 cm 200

F(1)

	-500	+500	+2000	+5000
Color 29	0,280 €	0,270 €	0,260 €	0,250 €
	0,330 €	0,320 €	0,310 €	0,300 €



01 60 05 226

ORCA_ 7535

Bolsa reutilizable cosida de acabado laminado mate. Fabricada en resistente non-woven RPET de 100 g/m² con asas reforzadas y ribetes a juego.

42 x 35 x 15 cm 10 200

F(1)

-500	+500	+2000	+5000
1,53 €	1,46 €	1,40 €	1,34 €



01 03 31 60



05 226 02 40

PHOCA_ 7534

Bolsa reutilizable cosida de acabado laminado mate. Fabricada en resistente non-woven RPET de 100 g/m² con asas reforzadas.

41 x 37 cm 10 250

F(1)

-500	+500	+2000	+5000
0,910 €	0,870 €	0,830 €	0,790 €

RPETbags



02 01 60 226 05

PANTALA_ 7549

Bolsa de la compra plegable realizada en suave poliéster reciclado 210T. Práctico bolsillo para su plegado incluido.

33 x 46 x 8 cm 20 400

F(1), G(1), R

-500	+500	+2000	+5000
1,40 €	1,36 €	1,31 €	1,24 €



**VOLGA_ 7147**

Set de 3 bolsas de reciclaje. Realizadas en resistente pp-woven laminado mate con velcros laterales. Asas reforzadas. Capacidad de cada bolsa: 40 litros.

99 x 44 x 28 cm 1 40

F(1)

-500	+500	+2000	+5000
4,52 €	4,32 €	4,12 €	3,92 €

recyclingset



01

31

60



05

226

02

COAST_ 7543

Bolsa reutilizable en acabado laminado brillante. Resistente PP woven de 120 g/m² con asas reforzadas de nylon y ribetes a juego en negro.

39 x 39 x 15 cm 20 100

F(1)

-500	+500	+2000	+5000
1,55 €	1,49 €	1,43 €	1,30 €



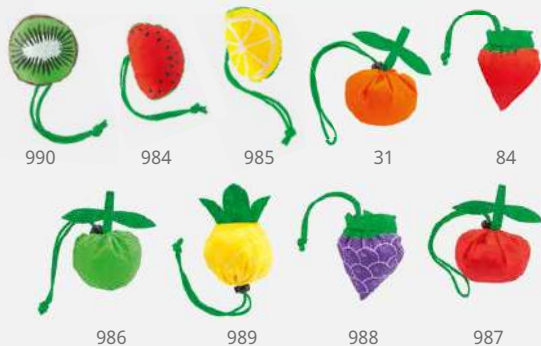

FOCHA_ 7523

Bolsa de la compra plegable de suave poliéster 190T. Variados diseños de frutas con cordón ajustable de cierre.

38 x 38 cm 10 400

F(1), G(1)

-500	+500	+2000	+5000
0,920 €	0,900 €	0,870 €	0,830 €



ALONDRA_ 7524

Bolsa de la compra plegable realizada en non-woven con cierre de velcro y práctico bolsillo exterior. Asas cortas de 37 cm.

38 x 42 cm 50 200

F(1), G(1), H(1)

-500	+500	+2000	+5000
0,630 €	0,610 €	0,590 €	0,550 €



TOCO_ 7522

Bolsa de la compra plegable de suave poliéster 190T en acabado cosido. Incluye práctica banda elástica para su plegado.

42,5 x 38 x 7 cm 20 400

E(1), G(1), H(1), R

-500	+500	+2000	+5000
0,800 €	0,780 €	0,750 €	0,730 €



crest



mito

sublimation

**CREST_ 7506**

Bolsa de non-woven de 80 g/m² con asas largas de 70 cm. Acabado termosellado.

36 x 40 cm 25 250

F(1)

-500	+500	+2000	+5000
0,386 €	0,370 €	0,358 €	0,354 €

MITO_ 7527

Bolsa de la compra en non-woven cosido con asas reforzadas. Ideal para sublimación. Asas de 70 cm.

36 x 40 cm 50 250

F(1), N(8), R

-500	+500	+2000	+5000
0,560 €	0,540 €	0,520 €	0,500 €

donet

trento
sublimation**DONET_ 7126**

Bolsa de non-woven 80 g/m² con resistentes asas troqueladas y acabado termosellado.

34 x 43 cm 50 400

F(1)

-500	+500	+2000	+5000
0,280 €	0,240 €	0,234 €	0,224 €

TRENTO_ 7127

Bolsa sublimable de non-woven 80 g/m² con resistentes asas troqueladas y acabado termosellado. Ideal para sublimación.

43 x 34 cm 20 400

F(1), N(8), R

-500	+500	+2000	+5000
0,400 €	0,380 €	0,360 €	0,340 €



57 450 56 02

fundas para jamón

TREVEL_ 7128

Funda para jamón de resistente non-woven con asas reforzadas y cierre de cremallera. Acabado cosido.

68 x 41 cm 50 100

F(1)

-500	+500	+2000	+5000
1,21 €	1,17 €	1,15 €	1,13 €



55 56 57 02

RIVER_ 7502

Bolsa termosellada con diseño especial para botellas. Asa integrada en el cuerpo. Fabricada en non-woven de 80 g/m².

17 x 40 x 10 cm 50 1000

F(1)

-500	+500	+2000	+5000
0,140 €	0,130 €	0,126 €	0,120 €



01 60 55
236 99 02

OCEAN_ 7501

Bolsa termosellada de non-woven de 80 g/m² con asa integrada en el cuerpo.

40 x 30 x 10 cm 50 400

F(1)

-500	+500	+2000	+5000
0,292 €	0,282 €	0,276 €	0,270 €

non-woven



236



01 60 99 226 02 78

SEA_7504

Bolsa termosellada de non-woven de 80 g/m² con asas largas y fuelle hexagonal.

54 x 40 x 10 cm 50 250

F(1)

-500	+500	+2000	+5000
0,590 €	0,570 €	0,550 €	0,530 €



01 03 31 60 05 226 02

LAKE_7503

Bolsa termosellada de non-woven de 100 g/m² con asas cortas.

35 x 40 x 12 cm 50 250

F(1)

-500	+500	+2000	+5000
0,640 €	0,630 €	0,610 €	0,590 €



01 03 31 60 05 226 02 40

BODEN_7125

Bolsa de non-woven 80g/m². Asas cortas reforzadas de 35 cm y acabado termosellado.

38 x 35 cm 50 250

F(1)

-500	+500	+2000	+5000
0,286 €	0,276 €	0,270 €	0,262 €



01 31 60 05 226 02

BARNET_7166

Bolsa de gran tamaño realizada en non-woven de 80 g/m². Asas reforzadas de 58 cm y acabado cosido.

33 x 38 x 25 cm 10 200

F(1)

-500	+500	+2000	+5000
1,23 €	1,17 €	1,13 €	1,06 €

new **rp**pet **cooler** bags

new.

new.



243



255

MARLOX_ 7609

Nevera XL de poliéster reciclado RPET con diseño vigoré. Doble compartimento y bolsillo frontal. Interior isométrico. Incluye cinta de transporte ajustable.

25,5 x 16 x 11 cm



1



25

G(1), N(8)

-500	+500	+2000	+5000
7,90 €	7,70 €	7,44 €	7,22 €



243



255

BISMAR_ 7608

Nevera de poliéster reciclado RPET con diseño vigoré. Bolsillo frontal e interior isotérmico. Incluye cinta de transporte ajustable.

25 x 14,5 x 15,5 cm



1



60

G(1), N(8)

-500	+500	+2000	+5000
5,90 €	5,70 €	5,44 €	5,22 €



60

05

02

GRULLA_7605

Nevera multiusos de poliéster 600D. Compartimentos interiores isotérmicos y prácticos bolsillos exteriores. Cinta bandolera acolchada ajustable con mosquetón.

25 x 24 x 15 cm 1 20

G(1), N(8)

-500	+500	+2000	+5000
8,80 €	8,40 €	8,20 €	7,90 €

for your adventures

**BELVER_4030**

Set de cubiertos de acero inoxidable presentados en una práctica funda de neopreno. Incluye tenedor, cuchillo y cuchara.

21 x 6 cm 1 100

F(1), L2

-500	+500	+2000	+5000
4,78 €	4,58 €	4,38 €	3,98 €

PROLY®



58



243



255

CHUCAO_7146

Mochila para portátil de poliéster en acabado jaspeado. Tirantes, espalda y asa acolchadas. Doble compartimento frontal y bolsillos laterales. Etiqueta removible.

28 x 43 x 13 cm 1 15

Consultar

Caja	Pack	Unidad
12,500 €	13,125 €	-



recycled PET



58

255

MALMO_ 7106

Mochila realizada en poliéster reciclado RPET 600D con diseño vigoré. Cuerpo y bolsillo interior acolchados ideal para portátil. Doble compartimento con cremallera impermeable y bolsillo exterior. Asas acolchadas y cinta para trolley.

31 x 42 x 12 cm 1 20

G(1), N(8)

-500	+500	+2000	+5000
20,60 €	19,50 €	18,80 €	18,10 €



new/sidney



SIDNEY_ 7176

Mochila realizada en poliéster reciclado RPET 600D con diseño vigoré. Cuerpo y bolsillos interiores acolchados ideal para portátil y tablet. Doble compartimento y bolsillos laterales. Asas acolchadas.

31 x 45 x 13 cm 1 20

G(1), N(8)

-500	+500	+2000	+5000
19,98 €	19,30 €	18,60 €	17,90 €



new.



new.

anti-**robo****MOANA_7172**

Mochila antirrobo realizada en nylon. Compartimento con salida USB para conectar un power bank (no incluido). Incluye cable micro USB. Bolsillo multiusos en tira derecha. Bolsillo principal con dos compartimentos acolchados ideal para portátil y tablet. Tiras y espalda acolchadas.

30 x 44 x 16 cm 1 10

G(1), N(8)

-500	+500	+2000	+5000
51,00 €	49,00 €	47,00 €	46,00 €

new mardok

new.



02

58

55

MARDOK_7173

Mochila realizada en nylon 600D. Tiras y espalda acolchadas. Incluye compartimento interior acolchado ideal para portátil.

32,5 x 44 x 25 cm

5

20

G(1), N(8)

-500	+500	+2000	+5000
24,00 €	23,00 €	22,00 €	19,00 €



new.



02

55

DUKE_7171

Mochila realizada en nylon. Bolsillo interior acolchado ideal para portátil. Tiras y espalda acolchadas. Compartimento con salida USB para conectar un power bank (no incluido). Incluye cable micro USB.

30 x 45 x 20 cm 1 10

G(1), N(8)

-500	+500	+2000	+5000
40,44 €	39,30 €	38,20 €	37,00 €

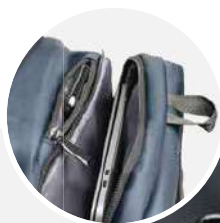

porta**documentos**



58



255

KALMAR_7500

Portadocumentos acolchado para portátil realizado en poliéster reciclado RPET 600D con diseño vigoré. Dos compartimentos con cremallera impermeable. Asas de transporte y cinta bandolera ajustable a juego. Incluye cinta para trolley.

37 x 28 x 5 cm 1 30

F(1), N(8)

-500	+500	+2000	+5000
13,40 €	13,00 €	12,60 €	12,10 €





29

31

05



226

02

60

**LORA_7515**

Portadocumentos acolchado para portátil en suave poliéster 600D con bolsillo exterior. Asas de transporte a juego y cinta bandolera ajustable con mosquetón.

40,5 x 30 x 5,5 cm



1



50

F(1), N(8)

-500	+500	+2000	+5000
6,36 €	6,10 €	5,86 €	5,60 €



31



01

60

55



05



226



02

CHARRAN_7517

Portadocumentos de poliéster 600D en variados colores con asa de transporte y cremallera a juego.

40 x 29,5 x 5,5 cm



20



100

F(1), N(8)

-500	+500	+2000	+5000
1,27 €	1,25 €	1,21 €	1,17 €



60

55

05

02

LIBE_7516

Portadocumentos de poliéster 600D con un compartimento principal y cierre de cremallera. Ribetes con refuerzo y asa de transporte integrada en el diseño.

38 x 32 cm



20



100

F(1), N(8)

-500	+500	+2000	+5000
1,39 €	1,33 €	1,26 €	1,19 €



29



29

60



55

02

GARZA_ 7518

Portadocumentos de viaje con cierre de velcro y práctica trabilla para el cinturón. Poliéster 600D.

27 x 13 cm 40 400

E(1), N(8)

-500	+500	+2000	+5000
0,580 €	0,550 €	0,520 €	0,500 €

disfruta de tu viaje



01

60

05

02

GORDON_ 3014

Adaptador de viaje universal. Válido para su uso en europa, asia, reino unido, estados unidos y australia. Presentación en caja blanca.

8,2 x Ø4,5 cm 50 100

D(4)

-500	+500	+2000	+5000
2,50 €	2,40 €	2,30 €	2,20 €



INDICADOR LED

01

02

BOPP_ 3013

Adaptador de viaje universal de diseño compacto y retráctil, con acabado mate y tacto suave. Válido para su uso en europa, asia, reino unido, estados unidos y australia. 2 puertos USB. Velocidad de carga 2100 mAh. Presentación en caja blanca.

6,1 x 5,6 x 4,5 cm 50 100

D(4), W

-500	+500	+2000	+5000
9,80 €	9,50 €	9,10 €	8,60 €

comodidad y relax



258



55



02

ANSAR_ 8201

Almohadilla inflable de viaje con suave tacto antelina.

33 x 9 x 25 cm 20 200

F(1)

-500	+500	+2000	+5000
0,960 €	0,940 €	0,890 €	0,860 €



BRANTA_ 8200

Máscara de viaje realizada en suave microfibra. Doble elástico de ajuste.

18,5 x 9 cm 100 1000

D(1), N(8)

-500	+500	+2000	+5000
0,330 €	0,320 €	0,300 €	0,280 €



01



02

YLLIER_ 8151

Zapatillas unisex realizadas en cómodo algodón/ poliéster con interior acolchado. Práctica funda de non-woven incluida. Talla única 36-43.

11,5 x 29 x 1,7 cm 10 200

E(1), N(8)

-500	+500	+2000	+5000
1,63 €	1,58 €	1,53 €	1,48 €



231

60

55

15



DODO_7138

Mochila multifunción de poliéster 900D. Gran compartimento principal de apertura extensible con cremallera y ajustadores. Bolsillos laterales. Espalda y asas acolchadas. Etiqueta removible.

44 x 30 x 10 cm 1 10

Consultar

Caja	Pack	Unidad
13,960 €	14,658 €	-

AROLY®



96

57

05



86

02

38



COLIBRI_7510

Mochila de diseño urbano realizada en 70% poliéster y 30% algodón. Compartimento principal de gran capacidad. Bolsillo frontal con cremallera a juego. Etiqueta removible.

28 x 36 x 11 cm 1 20

Consultar

Caja	Pack	Unidad
11,800 €	12,390 €	-

MAROLY®



03 31 60 55 05



12 226 15 78 02



MARABU_7124

Mochila clásica con compartimentos de gran capacidad, realizada en poliéster 900D. Espalda y tirantes acolchados. Etiqueta removible.

30 x 40 x 18 cm  1  20

 Consultar

Caja	Pack	Unidad
9,300 €	9,765 €	-



256 248 246





135 243 252



TEROS_7145

Mochila clásica de poliéster 300D con acabado jaspeado. Bolsillo frontal con salida para cables. Espalda y tirantes acolchados. Detalles en negro. Etiqueta removible.

30 x 40 x 12 cm  1  20

 Consultar

Caja	Pack	Unidad
7,400 €	7,770 €	-

choosey

new.



03 31 60 48



05 55 02



01 03 60 05



226 40 02

WILDE_ 7174

Mochila realizada en poliéster 600D con dos compartimentos principales y bolsillo frontal. Bolsillo de redcilla lateral. Tiras y espalda acolchadas.

31 x 41 x 16 cm 1 40

F(1), N(8), O, P

-500	+500	+2000	+5000
9,50 €	9,10 €	8,70 €	8,30 €

TUCAN_ 7158

Mochila clásica de resistente poliéster 600D, con compartimento principal y bolsillo frontal. Cierre de cremallera con tirador para fácil apertura. Espalda y tirantes acolchados. Etiqueta removible.

28 x 38 x 12 cm 1 50

F(1), N(8), O, P

-500	+500	+2000	+5000
4,50 €	4,30 €	4,10 €	3,96 €

color



01

03

60

05



55

226

02

232

CONDOR_ 7153

Mochila de poliéster 600D con cierre de cremallera. Bolsillo frontal con salida para cables. Bolsillos laterales de diseño microperforado. Etiqueta removible.

30 x 40 x 18 cm 1 40

F(1), N(8), O

-500	+500	+2000	+5000
3,44 €	3,32 €	3,20 €	3,10 €



01

03

31

60

05



55

28

02

78

SISON_ 7154

Mochila ligera y compacta, en resistente poliéster 600D. Bolsillo frontal con apertura vertical y acolchado en espalda y tirantes. Etiqueta removible.

23 x 40 x 12 cm 1 50

F(1), N(8), O, R

-500	+500	+2000	+5000
3,20 €	3,04 €	2,92 €	2,82 €

new.

recycled cotton



29 60 05 226 02



BRESCIA_7165

Mochila de cordones en algodón reciclado de 120g/m² con acabado jaspeado y cordones en color natural.

38 x 42 cm 50 200

F(4), N(8)

-500	+500	+2000	+5000
1,96 €	1,88 €	1,82 €	1,72 €



29 60 05 226 02



VARESE_7107

Bolsa mochila de cordones en algodón reciclado de 140 g/m² con acabado jaspeado con asas largas de 70 cm a juego y cordones en color natural.

38 x 42 cm 20 100

F(6), N(8), O, P

-500	+500	+2000	+5000
2,68 €	2,56 €	2,46 €	2,36 €



organic cotton



MUNA_7098

Mochila de cordones 100% de algodón orgánico.

38 x 42 cm 20 100

F(6), N(8), O, P

-500	+500	+2000	+5000
2,06 €	1,98 €	1,90 €	1,88 €

new

100% algodón

**MIRLO_ 7137**140 gr/m²

Mochila de cordones en 100% algodón de 140 g/m².
Cordones de 8 mm. Etiqueta removible.

34 x 42 cm 10 200

F(6), N(8), O, P

-500	+500	+2000	+5000
1,36 €	1,32 €	1,28 €	1,24 €

**ADARE_ 7175**105 gr/m²

Mochila 100% de algodón con cordones a juego.

37 x 41 cm 10 100

F(6), N(8), M, O, P

-500	+500	+2000	+5000
1,52 €	1,48 €	1,42 €	1,36 €

cotton & jute

120 gr/m²**WILKES_ 7557**

Mochila de cordones realizada en algodón de 120 g/m² y yute.

34 x 43 cm 10 100

F(6), N(8), O, P

-500	+500	+2000	+5000
1,98 €	1,88 €	1,80 €	1,68 €

recycled pet



01

60

05



226

02

LARUS_7550

Mochila de cordones realizada en suave poliéster reciclado 210D con esquinas reforzadas.

34 x 42 cm

50

300

F(1), R

-500	+500	+2000	+5000
1,24 €	1,19 €	1,15 €	1,11 €



01

03

31

60



05

20

02

48



63

78

55

HAMELIN_7114

Mochila de cordones con ojales metálicos, realizada en poliéster 210D. Etiqueta removible.

34 x 42 cm

50

300

F(1), N(8), R

-500	+500	+2000	+5000
0,840 €	0,820 €	0,790 €	0,750 €



31



01

03

60

05



55

226

02

78

KAGU_7155

Mochila con cordones gruesos a juego realizada en poliéster 210T. Cordones de 8 mm. Etiqueta removable.

35 x 45 cm 10 200

F(1), N(8), R

-500	+500	+2000	+5000
1,00 €	0,980 €	0,960 €	0,940 €



31

60

05

02

CUANCA_7150

Mochila de cordones con ojales metálicos, realizada en poliéster 210D. Bolsillo frontal de diseño microperforado con cierre de cremallera y salida para cables. Etiqueta removable.

34 x 43 cm 10 200

F(1), N(8)

-500	+500	+2000	+5000
1,20 €	1,18 €	1,16 €	1,14 €



01

03

60

05

02

78

NINFA_7152

Mochila de cordones con esquinas reforzadas realizada en poliéster 210D. Bolsillo frontal con cremallera y salida para cables. Etiqueta removable.

34,5 x 45 cm 10 200

F(1), N(8), R

-500	+500	+2000	+5000
1,18 €	1,14 €	1,10 €	1,04 €



991



992



993

MILANO_7526

Mochila de cordones en poliéster 190T, con diseños deportivos.

43,5 x 43 cm

50

300

F(1)

-500	+500	+2000	+5000
0,900 €	0,860 €	0,830 €	0,800 €



0102

3102

6002

5502



9902

22602

0202

7802

GAVILAN_7509

Mochila de cordones de non-woven de 70 g/m² en diseño bicolor efecto metalizado.

34 x 42 cm

50

250

F(1)

-500	+500	+2000	+5000
0,780 €	0,770 €	0,760 €	0,740 €



01

03

31

60



05

226

02

78

CALAO_7151

Mochila de cordones con ojales metálicos realizada en non-woven de 80 g/m². Etiqueta removible.

36 x 42 cm

10

300

F(1)

-500	+500	+2000	+5000
0,620 €	0,610 €	0,600 €	0,580 €

**PACHU_ 9131**

Delantal infantil de non-woven con diseño para colorear. 5 ceras en varios colores incluidas. Talla única ajustable.

43 x 43 cm 50 200

F(1)

-500	+500	+2000	+5000
0,800 €	0,770 €	0,750 €	0,710 €

**AZOR_ 7529**

Bolsa infantil de non-woven con diseño para colorear. Incluye 5 ceras en colores variados.

20,5 x 22 cm 50 100

F(1)

-500	+500	+2000	+5000
0,330 €	0,320 €	0,310 €	0,290 €

**TURCAZ_ 7530**

Mochila infantil de cordones realizada en non-woven, con diseño para colorear. Incluye 5 ceras en colores variados.

25 x 30 cm 50 200

G(1)

-500	+500	+2000	+5000
0,490 €	0,470 €	0,450 €	0,430 €



995

996

997

998

ELANIO_ 7528

Mochila infantil de cordones plegable en poliéster 190T. Bolsillo para plegado con diseños de animales.

26,5 x 32,5 cm 10 500

F(1), G(1)

-500	+500	+2000	+5000
1,41 €	1,35 €	1,29 €	1,23 €

ROLY®

macutos deportivos



0258



4658



78252

JOGGER_7117

Bolsa combinada de poliéster 300D con doble asa ajustable y base reforzada. Bolsillo lateral con cremallera invertida. 20 L de capacidad. Etiqueta removible.

42 x 27 x 27 cm 1

20

Consultar

Caja	Pack	Unidad
7,900 €	8,295 €	-

new novak



55



02

NOVAK_7170

Bolso multifunción de poliéster 600D de gran capacidad. 5 compartimentos con cierre de cremallera. Base reforzada. Incluye cinta bandolera ajustable con almohadilla.

65 x 33 x 34 cm 1 10

G(1), N(8)

-500	+500	+2000	+5000
25,90 €	24,90 €	23,90 €	22,80 €

new.



60

05

55

02

CANARY_7121

Bolsa deportiva con doble asa y asa larga ajustable para colgar. Bolsillo principal con doble tirador. Bolsillo zapatillero con compartimento extraíble. Anti-humedad. Base con tacos. Fácil limpieza. 72 L de capacidad. 100% poliéster 600D, 330 g/m².

42 x 48 x 26 cm 1 10

Consultar

Caja	Pack	Unidad
15,900 €	16,695 €	-



AROLY

new canary

ZOROLY®

mochilas deportivas



01

60

05

55

02

ZORZAL_7157

Mochila deportiva de diseño plano y fácil personalización: Cordones planos a tono. Bolsillo interior con cremallera. 100% Poliéster 600D. 150 g/m²

35,5 x 42,5 cm

10

200

Consultar

Caja	Pack	Unidad
2,040 €	2,142 €	-

new.



FALCO_7115

Bolsa deportiva con doble asa y asa larga ajustable para colgar. Bolsillo principal con doble tirador. Bolsillo zapatillero con compartimento extraíble. Anti-humedad. Base con tacos. Fácil limpieza. 72 L de capacidad. 100% poliéster 600D, 330 g/m².

34 x 65 x 33 cm 1 10

Consultar

Caja	Pack	Unidad
15,00 €	15,75 €	-

new.

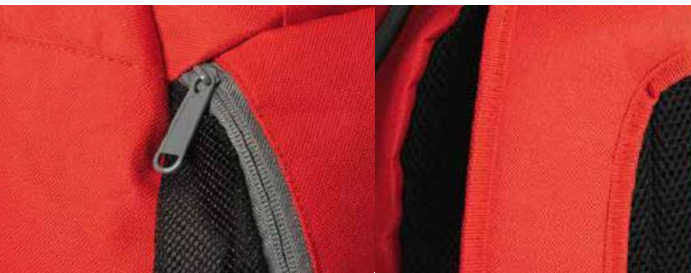

COLUMBA_7120

Bolsa deportiva con doble asa y asa larga ajustable para colgar. Bolsillo principal con doble tirador. Bolsillo zapatillero con compartimento extraíble. Anti-humedad. Base con tacos. Fácil limpieza. 72 L de capacidad. 100% poliéster 600D, 330 g/m².

34 x 65 x 33 cm 1 10

Consultar

Caja	Pack	Unidad
15,900 €	16,695 €	-

new.

jute & cotton



new.

VERA_ 7563

Neceser realizado en algodón y yute laminado. Cremallera con tirador de yute a juego.

20 x 15 x 6 cm  50  200

 E(1), N(8)

-500	+500	+2000	+5000
2,08 €	2,02 €	1,90 €	1,82 €

SIENA_ 7564

Neceser realizado en algodón y yute laminado. Cremallera con tirador de yute a juego.



21 x 11 x 6 cm  50  200

 E(1), N(8)

-500	+500	+2000	+5000
2,30 €	2,20 €	2,10 €	1,98 €

**SIERRA_ 7558**

Neceser multiusos realizado en algodón de 180 g/m² y yute. Cremallera con tirador de yute a juego.

21,5 x 16 x 5 cm  10  200

 E(1), N(8)

-500	+500	+2000	+5000
1,50 €	1,44 €	1,39 €	1,35 €

**TYTO_ 7560**

Neceser de yute natural con cremallera a juego. Tirador de yute.

22 x 14 x 6,5 cm  10  200

 E(1)

-500	+500	+2000	+5000
1,01 €	0,970 €	0,940 €	0,900 €

 **organic**cotton



60 05 226 29 02



DELPHIS_7536

Neceser 100% algodón orgánico de 180 g/m² con tirador a juego.

 21 x 16 cm  50  300

 E(1), N(8), O

-500	+500	+2000	+5000
1,24 €	1,18 €	1,14 €	1,08 €

 **recycled**cotton



60 05 226 29 02



REMO_7562

Neceser multiusos en algodón reciclado con cremallera y tirador a juego.

 21 x 12 x 3 cm  50  300

 E(1), N(8), O

-500	+500	+2000	+5000
1,14 €	1,10 €	1,04 €	1,00 €

100% natural



2929 2960 2905



29226 2902

DOEL_7537

Neceser multiusos en algodón de 280 g/m² con acabado bicolor. Cremallera con tirador de algodón a juego.

 22,5 x 17 x 5,5 cm  50  300

 E(1), N(8)

-500	+500	+2000	+5000
1,70 €	1,63 €	1,57 €	1,50 €





new.



29 31 60 05 02 40

SEDNA_7565

Necesar multiusos de poliéster 600D. Cierre de cremallera con tirador a juego.

22 x 6 x 14 cm 20 300

E(1), N(8), O

-500	+500	+2000	+5000
1,04 €	1,00 €	0,960 €	0,920 €



29 31 60 55 05 56 02

PARDELA_7513

Necesar de poliéster 600D con cremallera y práctica asa de transporte.

20 x 9,8 x 8,3 cm 10 200

F(1), N(8), O

-500	+500	+2000	+5000
1,12 €	1,08 €	1,05 €	1,03 €



01 60 05 226 02

BUBO_7547

Necesar de dos compartimentos con cremalleras y cinta de transporte a juego. Realizado en poliéster reciclado RPET 210D.

21 x 13 x 8 cm 20 100

F(1), N(8), O

-500	+500	+2000	+5000
2,68 €	2,58 €	2,48 €	2,38 €



29 31 60 05 02 40

YUBARTA_7514

Necesar de poliéster 600D. Cremallera con tirador a juego.

22 x 14 x 6 cm 10 300

E(1), N(8), O

-500	+500	+2000	+5000
0,940 €	0,910 €	0,860 €	0,820 €



05

226

258

02

GRUS_ 7512

Neceser de poliéster 300D a color en acabado vigoré y PVC transparente, con cremallera y práctica asa de transporte.

23,5 x 18,5 cm 100 200

E(1)

-500	+500	+2000	+5000
1,21 €	1,17 €	1,12 €	1,05 €



60



03



01

31

60

05

226

40

CARIBU_ 7511

Neceser de PVC translúcido con cierre hermético.

17 x 13 x 5 cm 50 400

E(1)

-500	+500	+2000	+5000
0,510 €	0,490 €	0,470 €	0,450 €

especial

aeropuertos

ARNOLD_ 9935

Neceser de viaje transparente realizado en PVC con cierre hermético. Incluye surtido de prácticos botes ideales para gel, champú y perfume.

19 x 19 cm 1 100

E(1)

-500	+500	+2000	+5000
1,98 €	1,89 €	1,79 €	1,69 €



BOLSILLO TRASERO



01 03 31 60



05 226 02

VULTUR_7548

Riñonera de poliéster 600D con dos compartimentos, uno frontal y otro trasero. Cremalleras y tiradores a juego. Cinta ajustable.

25 x 17 x 8 cm 20 100

E(1), N(8)

-500	+500	+2000	+5000
2,30 €	2,20 €	2,00 €	1,90 €



01 60



05 226 02

ADAL_7544

Monedero con 2 bolsillos realizado en agradable polipiel RPET con cremalleras a juego. Anilla llavero incluida en el interior.

10,5 x 9 cm 10 500

D(1), L1

-500	+500	+2000	+5000
0,680 €	0,640 €	0,600 €	0,580 €



01 03 31 60



05 226 02 40

MEDEA_7542

Monedero realizado en agradable polipiel con cremallera a juego. Anilla llavero incluida en el interior.

10,5 x 7,5 x 0,5 cm 20 1000

D(1), L1

-500	+500	+2000	+5000
0,310 €	0,300 €	0,290 €	0,280 €



NATURAL
CORK**LIMOSA_ 7545**

Monedero de corcho natural con forro interior y cremallera. Anilla de transporte incluida.

11 x 9 cm

100

800

D(1), L2

-500	+500	+2000	+5000
0,900 €	0,860 €	0,820 €	0,780 €

corcho natural

NATURAL
CORK**VESPULA_ 7546**

Estuche de corcho natural con forro interior de poliéster y cremallera.

23 x 11 x 2 cm

50

200

E(1), L2

-500	+500	+2000	+5000
1,75 €	1,68 €	1,61 €	1,54 €

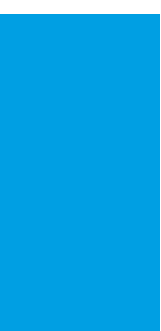

**WINTER &
RAINY DAYS**



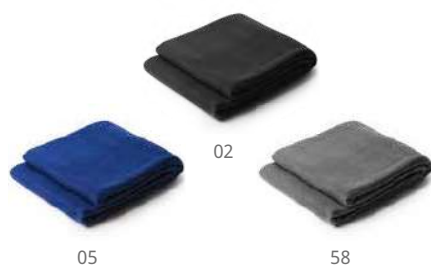

BRANDON_ 5624

Manta de forro polar realizada en poliéster reciclado RPET con práctica funda. Tratamiento anti-pilling. 200 g/m².

150 x 120 cm 1 20

G(1), H(1), N(8), O, P

-500	+500	+2000	+5000
10,80 €	10,40 €	9,96 €	9,50 €



new.



60 05 55 226 58 02



DANERIS_ 5625

Manta de forro polar con tratamiento anti-pilling. Incluye asa de transporte con cierre de velcro. 100% poliéster de 200 g/m².

160 x 130 cm 1 25

G(1), N(8), O, P

-500	+500	+2000	+5000
7,90 €	7,70 €	7,40 €	7,20 €



31 60 05



226 58 02



LAMBERT_ 5621

Manta de forro polar con tratamiento anti-pilling. 100% poliéster de 180 g/m².

120 x 150 cm 1 20

N(8), O, P

-500	+500	+2000	+5000
5,70 €	5,50 €	5,22 €	5,02 €



60 55 58 02



ANTI-PILLING

BERING_5622

Manta de forro polar con práctica funda a juego en acabado Oxford con rejilla. Tratamiento anti-pilling. 100% poliéster de 200 g/m².

130 x 160 cm 1 20

G(1), H(1), N(8), O, P

-500	+500	+2000	+5000
7,70 €	7,50 €	7,22 €	7,02 €



TRANSPIRABLE



TÁCTILES



05 226 58 60 02

ZELAND_5623

Guantes táctiles (dedos pulgar, índice y corazón). Zona táctil en diferente color al resto del guante. Talla única adulto. Fabricado en acrílico.

21 x 11,5 cm 10 200

N(8)

-500	+500	+2000	+5000
1,42 €	1,38 €	1,33 €	1,28 €



FORRO POLAR

IMPERMEABLE



02 07 15 55

FROSTY_6998

Gorro estilo bob reversible. Exterior de nylon e interior en forro polar.

Ø60 cm 25 100

F(1), N(8), O

-500	+500	+2000	+5000
3,08 €	2,92 €	2,78 €	2,60 €

+ antibacterial

ISO 22196



STODDART_ 9936

Braga multiusos realizada en suave poliéster con tratamiento anti-bacterias. Gramaje de 150 g/m².

26 x 48 cm 10 300

F(1), N(8), R

-500	+500	+2000	+5000
1,52 €	1,46 €	1,40 €	1,32 €

ROLY



NUKKA_ 2009

Braga gorro en acabado polar con ajustador elástico. Modelo a prueba de viento. 100% poliéster polar 210 g/m².

30 x 25 cm 10 100

Consultar

Caja	Pack	Unidad
1,200 €	1,260 €	-



ROLY



PLANET_ 9009

Gorro de punto con doble vuelta, especial para bordado. 100% acrílico. Etiqueta removible.

10 200

Consultar

Caja	Pack	Unidad
1,700 €	1,785 €	-

ROLY



SUBLIMABLE



NANUK_ 9004

Braga para cuello multifunción de diseño tubular y corte recto. 100% poliéster tacto algodón de 130 g/m².

25 x 50 cm 25 500

Consultar

Caja	Pack	Unidad
0,680 €	0,714 €	-



Ø95

SUBLIMABLE



01 03 31 60 05 226 02 40

YAKU_ 5606

Paraguas plegable de apertura manual con funda a juego. Mango, varillas y contera plateados. Cierre con velcro. Fabricado en poliéster 190T.

24 x Ø5 cm 1 60
G(1), N(8), R

-500	+500	+2000	+5000
3,30 €	3,20 €	3,10 €	3,00 €

100%
poliéster
reciclado

SUBLIMABLE



01 60 05 02



WIND-PROOF

KHASI_ 5610

Paraguas plegable de poliéster reciclado 190T RPET con funda a juego. Bastón, varillas y terminaciones en negro. Mango de madera natural. Cierre con velcro a juego y apertura manual.

27,5 x Ø5,8 cm 1 50
G(1), N(8), L2

-500	+500	+2000	+5000
7,50 €	7,16 €	6,80 €	6,50 €



Ø95

MANGO MADERA



SUBLIMABLE



01 60 05 226 02 0102

MANGO MADERA

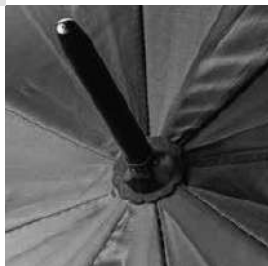

FARGO_ 5611

Paraguas con mango en madera y apertura automática. Varillas y terminaciones en negro. Cierre con velcro. Fabricado en poliéster 190T.

85 x Ø105 cm 1 40

G(1), N(8), R

-500	+500	+2000	+5000
4,74 €	4,60 €	4,40 €	4,24 €



SUBLIMABLE



01 60 55 05 02



WIND-PROOF

HARUL_ 5609

Paraguas XL de poliéster 190T con mango, bastón y terminaciones en negro. Varillas largas de fibra de vidrio con sistema anti-viento. Botón de apertura automática. Mango de EVA. Cierre con velcro a juego.

98 x Ø130 cm 1 25

G(1), N(8), R

-500	+500	+2000	+5000
5,60 €	5,50 €	5,30 €	5,14 €

MANGO ACOLCHADO



Ø105



Ø105



SUBLIMABLE



01 03 31 60 05 226 02

MILFORD_ 5608

Paraguas con tela y mango a juego. Varillas y terminaciones en negro. Cierre con velcro y apertura automática. Fabricado en poliéster 190T.

83 x Ø105 cm 1 25

G(1), N(8), R

-500	+500	+2000	+5000
4,50 €	4,30 €	4,10 €	3,90 €

SUBLIMABLE



01 60 55 05 226 02

LYSE_ 5607

Paraguas con mango, bastón y terminaciones en madera. Varillas en negro. Cierre con velcro a juego. Apertura manual. Fabricado en poliéster 190T.

90 x Ø105 cm 1 25

G(1), N(8), R

-500	+500	+2000	+5000
4,30 €	4,14 €	3,98 €	3,78 €



INCLUYE FUNDA



01

03

60

05

BAIKAL_ 5603

Chubasquero impermeable con acabados termosellados, cierre central con 4 corchetes, bolsillos laterales con tapeta, puños con botón ajustador, 3 aberturas de ventilación en la espalda y capucha ajustable con cordón. Talla única adulto. Funda incluida.

86 x 72 cm

10

50

F(1)

-500	+500	+2000	+5000
5,66 €	5,40 €	5,20 €	5,00 €

para días
lluviosos



03

60

05

DAMPER_ 5600

Poncho impermeable plegable, con capucha y apertura para los brazos, acabado termosellado y cierre lateral con conchete. Talla única 127 x 100 cm. Fabricado en PVC. Funda incluida.

22,5 x 18 cm

1

50

F(1), H(1)

-500	+500	+2000	+5000
3,26 €	3,16 €	3,00 €	2,90 €



new.



01

03

60

05

226

SHAKA_ 5601

Poncho impermeable plegable con capucha y abertura para los brazos. Talla única de adulto: 127 x 102 cm. Fabricado en polietileno de baja densidad (LDPE). Presentación en funda individual.

127 x 102 cm 50 200

E(1)

-500	+500	+2000	+5000
0,470 €	0,460 €	0,450 €	0,440 €



VOSTOK_ 5602

Poncho impermeable compostable con capucha y abertura para los brazos. Talla única de adulto: 127 x 102 cm. Fabricado en poliláctico (PLA). Presentación en funda individual de PLA.

127 x 102 cm 50 200

E(1)

-500	+500	+2000	+5000
1,24 €	1,20 €	1,16 €	1,08 €



**EATING &
DRINKWARE**



new
kumbo

new.



sublimation

300ml

KUMBO_4002

Taza de cerámica con diseño retro especial para sublimación. Capacidad 300 ml. Presentación en caja blanca.

8,5 x Ø8,7 cm 1 36



-500	+500	+2000	+5000
3,36 €	3,20 €	3,06 €	2,88 €



0102



0160



0105



300ml

JACK_4010

Taza de cerámica de estilo retro con asa redonda. Capacidad 300 ml. Presentación en caja blanca.

8,7 x Ø8,5 cm 1 36



-500	+500	+2000	+5000
2,80 €	2,76 €	2,66 €	2,56 €



0101



0301



3101



6001



24201



11401

sublimation mugs

ACABADO BRILLO



350ml

LIMA_ 4000

Taza de cerámica de 350 ml especial para sublimación. Presentación en caja blanca.

9,6 x Ø8,2 cm 1 36



-500	+500	+2000	+5000
2,18 €	2,14 €	2,04 €	1,96 €

ACABADO MATE



350ml

RAMBU_ 4003

Taza de cerámica de 350 ml con diseño en acabado mate. Especial para sublimación. Presentación en caja blanca.

9,6 x Ø8,2 cm 1 36



-500	+500	+2000	+5000
2,70 €	2,60 €	2,50 €	2,40 €



0103

0131

0160

0105

01226

0102

350ml

MANGO_ 4001

Taza de cerámica de 350 ml especial para sublimación. Interior y asa en color. Presentación en caja blanca.

9,6 x Ø8,2 cm 1 36



-500	+500	+2000	+5000
2,68 €	2,64 €	2,54 €	2,48 €

250ml

MARANG_ 4084

Taza de cerámica de 250 ml, especial para sublimación. Presentación en caja blanca.

8,4 x Ø7,4 cm 1 48



-500	+500	+2000	+5000
2,04 €	1,94 €	1,88 €	1,82 €





380ml

DAMASCO_ 4014

Taza metálica de estilo retro especial para sublimación. Capacidad 380 ml. Presentación en caja blanca.

7,9 x Ø8,8 cm 1 48

L2, Q

-500	+500	+2000	+5000
3,80 €	3,70 €	3,50 €	3,40 €

magic
mug



350ml

OKRA_ 4085

Taza mágica de cerámica en acabado mate. 350 ml de capacidad. Vierte líquido caliente en ella y descubre el diseño escondido. Presentación en caja blanca.

9,6 x Ø8,2 cm 1 36

F(1), Q

-500	+500	+2000	+5000
3,70 €	3,60 €	3,44 €	3,30 €



340ml

KAFFIR_ 4060

Taza de cristal de 340 ml. Especial para sublimación. Presentación en caja eco.

9,5 x Ø8 cm 1 36

Q

-500	+500	+2000	+5000
2,64 €	2,54 €	2,42 €	2,36 €



0101

0301

6001

0501

5601

0201

380ml

ANON_ 4015

Taza metálica de 380 ml con estilo retro.
Presentación en caja blanca.

7,9 x Ø8,9 cm 1 48

F(4), L2

-500	+500	+2000	+5000
2,02 €	1,92 €	1,86 €	1,80 €



metallic mugs



60

05

226

251

02

290ml

KIWAN_ 4083

Taza metálica de doble pared con exterior a color.
290 ml de capacidad. Presentación en caja blanca.

9 x Ø7,7 cm 1 50

F(1), L1

-500	+500	+2000	+5000
5,14 €	4,94 €	4,68 €	4,48 €



03

60

05

226

02

230ml

GUAYA_ 4082

Taza metálica de doble pared con asa mosquetón.
230 ml de capacidad. Presentación en caja blanca.

8 x Ø7 cm 1 50

F(1), L2

-500	+500	+2000	+5000
3,80 €	3,64 €	3,44 €	3,30 €



03

31

60



242

114

02



NOLO_ 4009

Taza de cerámica con esmalte a color de 300 ml.
Presentación en caja blanca.

10,4 x Ø8,5 cm 1 36

F(4)

-500	+500	+2000	+5000
3,90 €	3,80 €	3,64 €	3,50 €

new.



newnolo



0103

0131

0160

0105

01226



AKEBIA_ 4008

Taza de cerámica de 350 ml. Interior y cuchara a color. Presentación en caja blanca.

10,5 x Ø8,3 cm 1 36

F(4)

-500	+500	+2000	+5000
3,32 €	3,16 €	3,00 €	2,90 €



350ml

ZALA_4024

251

260

Taza de cerámica de 350 ml con diseño en acabado brillo. Especial para grabado láser. Presentación en caja blanca.

9,6 x Ø8,2 cm 1 36

F(4), L2

-500	+500	+2000	+5000
3,36 €	3,26 €	3,16 €	3,00 €



03

31

60

226

02

05

370ml

PAPAYA_4006

Taza de cerámica en color de 370 ml. Presentación en caja blanca.

9,8 x Ø8,2 cm 1 36

F(4)

-500	+500	+2000	+5000
2,90 €	2,86 €	2,70 €	2,60 €



01

03

60

05

350ml

PALTA_4007

Taza pizarra de 350 ml. Incluye tiza. Presentación en caja blanca.

9,6 x Ø8,2 cm 1 36

F(1)

-500	+500	+2000	+5000
2,86 €	2,76 €	2,66 €	2,58 €



370ml

YUCA_4005

Taza de cerámica de 370 ml. Presentación en caja blanca.

9,8 x Ø8,2 cm 1 36

F(4)

-500	+500	+2000	+5000
2,06 €	1,97 €	1,91 €	1,85 €



BAMBOO

BERRY_ 4012

Taza de cerámica en acabado mate con tapa de bambú natural. Capacidad 370 ml. Presentación en caja de cartón kraft.

10,5 x Ø8,2 cm 1 36

F(1), L2

-500	+500	+2000	+5000
4,94 €	4,68 €	4,48 €	4,28 €



ACABADO MATE



CORCHO

.....ACABADO MATE



BAMBOO

ROSELLA_ 4013

Taza de cerámica con diseño en acabado mate y base de corcho natural. Capacidad 420 ml. Presentación en caja de cartón kraft.

11 x Ø9 cm 1 36

F(1)

-500	+500	+2000	+5000
5,14 €	4,94 €	4,68 €	4,48 €



NATURAL CORK

SACHA_ 4057

Vaso reutilizable con 380 ml de capacidad. Cuerpo en PP con recubrimiento de corcho natural. Presentación en caja diseño eco.

8,5 x Ø11 cm 1 40

F(1), L2

-500	+500	+2000	+5000
2,92 €	2,82 €	2,66 €	2,56 €



**BUSTAN_4062**

Vaso reutilizable de PLA con tapa enroscable y 450 ml de capacidad.

13,5 x Ø9,4 cm 1 50

F(1)

-500	+500	+2000	+5000
3,52 €	3,42 €	3,26 €	3,16 €

**NUTRI_4022**

Vaso de papel de 500 ml. Capa interior de PLA. Biodegradable / compostable.

13,4 x Ø8,9 cm 50 1000

C(1)

-500	+500	+2000	+5000
0,220 €	0,210 €	0,200 €	0,180 €

**PARCHA_4063**

Taza reutilizable de PLA con 350 ml de capacidad.

8,8 x Ø7,9 cm 50 100

E(4)

-500	+500	+2000	+5000
2,82 €	2,72 €	2,60 €	2,50 €

PLA products

**YOBO_4065**

Fiambarrera realizada en PLA con cinta de ajuste en silicona. Tenedor, cuchara y cuchillo incluidos. Capacidad 1 lL

19,1 x 7,4 x 11,8 cm 1 40

E(1)

-500	+500	+2000	+5000
11,68 €	11,18 €	10,72 €	10,20 €





newdalia

new.

1L

DALIA_ 4107

Fiambarrera de cristal borosilicato con tapa hermética en PP. Capacidad 1l. Presentación en caja de diseño.

20,5 x 6,7 x 15,6 cm  1  20

 F(1)

-500	+500	+2000	+5000
9,78 €	9,36 €	8,98 €	8,58 €

**SAMBAL_ 4061**

Fiambarrera de cristal borosilicato con tapa de bambú y banda de silicona. 900 ml de capacidad. Presentación en caja diseño eco.



20 x 6 x 15 cm  1  20

 E(1), L2

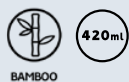
-500	+500	+2000	+5000
9,70 €	9,28 €	8,80 €	8,50 €

**COCO_ 4081**

Taza de cristal borosilicato con tapa y cuchara de bambú. 420 ml de capacidad. Presentación en caja diseño eco.

9,5 x Ø8 cm  1  36

 F(1), C(4), L2



-500	+500	+2000	+5000
7,20 €	6,20 €	5,80 €	5,60 €



1'2L

BRENA_ 4069

Fiambarrera de acero inoxidable 304 con sistema de cierre mediante hebillas laterales. Capacidad 1,2L. Presentación en caja diseño eco.

19,6 x 7 x 13,6 cm  1  20

 E(1), L2

-500	+500	+2000	+5000
11,98 €	11,68 €	11,38 €	10,78 €



fiambreras

de acero inoxidable



new.



BAMBOO

DAIKON_ 4103

Fiambarrera de acero inoxidable 304 con tapa de bambú. Sistema de cierre mediante hebillas laterales. Capacidad 1L. Presentación en caja diseño eco.

19,4 x 6,8 x 13,1 cm  1  20

 E(1), L2



-500	+500	+2000	+5000
13,40 €	12,90 €	12,40 €	11,80 €



BAMBOO

KORLAN_ 4066

Fiambarrera de acero inoxidable 304 con tapa de bambú y banda de seguridad en poliéster. Capacidad 800 ml. Presentación en caja diseño eco.

15,8 x 6,1 x 11,9 cm  1  30

 E(1), L2

-500	+500	+2000	+5000
10,90 €	10,40 €	9,90 €	9,30 €



**BELVER_ 4030**

Set de cubiertos de acero inoxidable presentados en una práctica funda de neopreno. Incluye tenedor, cuchillo y cuchara.

21 x 6 cm 1 100

F(1), L2

-500	+500	+2000	+5000
4,78 €	4,58 €	4,38 €	3,98 €

new.



BAMBOO

COLMER_ 4117

Set de cubiertos de bambú natural presentados en funda de algodón natural con cordón autocierre. Incluye tenedor, cuchillo y cuchara.

6,5 x 1 x 22 cm 100 300

F(1), B(4), L1, N(8)

-500	+500	+2000	+5000
1,94 €	1,86 €	1,78 €	1,70 €

**MALOW_ 4077**

Set de 2 pajitas de acero inoxidable 304 con funda de algodón. Cepillo limpiador incluido.

25,5 x 6 cm 100 400

E(1), L1, N(8)

-500	+500	+2000	+5000
1,46 €	1,41 €	1,36 €	1,31 €



01

02

LADAS_ 4068

Pajita extensible reutilizable de acero inoxidable 304 con boquilla de silicona. Cepillo limpiador y estuche con mosquetón para transporte incluidos.

10,5 x Ø1,6 cm 100 500

E(1), L1

-500	+500	+2000	+5000
1,03 €	1,00 €	0,960 €	0,930 €



**PARBU_ 4023**

Set de pajita y tenedor en estuche con mosquetón para transporte. PP / Silicona.

3,7 x 9,3 x 1,7 cm

50

400

B(4)

-500	+500	+2000	+5000
1,36 €	1,31 €	1,25 €	1,19 €

**+ antibacterial**

ISO 22196

*Material tratado con Iones de Plata que evita la ploriferación de las bacterias.



antibacterial
ISO 22196

GOSTO_ 4064

Vaso plegable anti-bacterias con tapa y mosquetón de transporte. 220 ml de capacidad.

9 x Ø3,7 cm

50

200

D(4), W

-500	+500	+2000	+5000
1,47 €	1,41 €	1,35 €	1,30 €

**FINGER_ 4021**

Pajita de silicona reutilizable, en práctico estuche de PP translúcido con llavero.

2 x Ø5,5 cm

100

500

B(4), W

-500	+500	+2000	+5000
0,390 €	0,378 €	0,358 €	0,338 €



03 31 60 05 226 01 40



PANA4097



SOTOS4100



FENGI4035

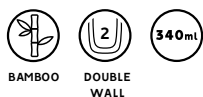

PANA_4097

Taza de acero inoxidable doble pared con exterior en bambú natural. Incluye tapa dosificadora. Capacidad 340 ml. Presentada en caja diseño eco.

10,8 x Ø8,2 cm 1 50

F(1), L2

-500	+500	+2000	+5000
13,50 €	12,90 €	12,40 €	11,80 €



SOTOS_4100

Bidón de acero inoxidable 304 con tapón de bambú. Incluye cinta para transporte. Capacidad 600 ml. Presentado en caja diseño.

22 x Ø6,3 cm 1 50

F(1), L2

-500	+500	+2000	+5000
7,36 €	7,10 €	6,86 €	6,60 €



FENGI_4035

Termo en acero inoxidable 304 de doble pared y bambú. Capacidad 420 ml. Incluye cinta de transporte. Presentación en caja diseño eco.

25,5 x Ø6 cm 1 25

F(1), L2

-500	+500	+2000	+5000
15,60 €	15,00 €	14,40 €	13,80 €

KINATA_4032



YABA_4033



bambú collection



BAMBOO DOUBLE WALL

**KINATA_ 4032**

Termo de acero inoxidable 304 doble pared. Pared exterior en bambú natural. Capacidad 500 ml. Presentación en caja diseño eco.

24,5 x Ø6,9 cm 1 30

F(1), L2

-500	+500	+2000	+5000
13,80 €	12,44 €	11,86 €	11,30 €



BAMBOO DOUBLE WALL

YABA_ 4033

Vaso de acero inoxidable 304 con pared exterior de bambú natural. Capacidad 500 ml. Presentación en caja diseño eco.

17,5 x Ø8,2 cm 1 50

F(1), L2

-500	+500	+2000	+5000
9,70 €	9,26 €	8,86 €	8,40 €

aislamiento de cobre al vacío



new.



DOUBLE WALL

YISEL_ 4093

Bidón térmico de acero 304 con doble capa y aislamiento de cobre al vacío. Capacidad 750 L. Presentación en caja diseño.

28,5 x Ø7,3 cm 1 20

F(1), L2

-500	+500	+2000	+5000
16,96 €	16,46 €	15,96 €	15,50 €



01 165 60 43 271 02



new.

DOUBLE
WALL**BALAX_4122**

Bidón térmico de acero inoxidable 304. Doble pared con aislamiento de cobre. Capacidad 550ml. Presentación en caja diseño.

22,5 x Ø7,4 cm 1 30

F(1), L2

-500	+500	+2000	+5000
12,98 €	12,60 €	11,98 €	11,60 €



60

05

02



251

281

260

botellas de acero inoxidable

DOUBLE
WALL**FANCY_4126**

Bidón térmico de acero inoxidable 304. Doble pared con aislamiento de cobre. Capacidad 500 ml. Presentación en caja diseño.

26,3 x Ø7 cm 1 30

F(1), L2

-500	+500	+2000	+5000
12,44 €	11,98 €	11,46 €	10,90 €
12,64 €	12,18 €	11,66 €	11,10 €

COLOR BLANCO 01

SUBLIMATION



01

60

05

260

251

02



new.



01

251

02

new.

new kale



KALE_ 4105

Bidón térmico de acero inoxidable 304 doble pared y base de corcho. Capacidad 520 ml. Presentación en caja diseño.

27 x Ø7,1 cm 1 30

F(1), L2

-500	+500	+2000	+5000
11,96 €	11,24 €	10,76 €	10,28 €

doble capa



COPO_ 4059

Bidón termo de acero inoxidable 304 con doble pared especial para sublimación. Capacidad 500 ml. Presentación en caja diseño.

25,5 x Ø7,3 cm 1 30

F(1), L2, Q

-500	+500	+2000	+5000
9,18 €	8,88 €	8,58 €	8,32 €



sublimation

new.

tarek



01

03

31

60



05

226

02

40

790ml

TAREK_ 4125

Bidón de acero inoxidable 304 de acabado mate. Capacidad 790 ml. Presentación en caja diseño.

25,7 x Ø7,4 cm 1 50

F(1), L2

-500	+500	+2000	+5000
5,40 €	5,20 €	5,00 €	4,80 €



01

60

05

251

02

700ml

ALPINIA_ 4042

Bidón de acero inoxidable 304. Capacidad 700 ml. Presentación en caja diseño.

25,5 x Ø7,1 cm 1 50

F(1), L2

-500	+500	+2000	+5000
5,20 €	5,00 €	4,80 €	4,60 €





01

60

05

02

850ml

ALKE_ 4034

Bidón de acero 304 con cuerpo en 2 tonos y acabado mate. Tapón con asa flexible de goma. Capacidad 850 ml. Presentación en caja diseño.

24,7 x Ø7,5 cm 1 30

F(1), L(2)

-500	+500	+2000	+5000
7,98 €	7,68 €	7,34 €	6,98 €

alke



01

60

05

226

02

630ml

PITA_ 4011

Bidón de acero inoxidable 304. Capacidad 630 ml. Diseño en color sólido de acabado mate. Presentación en caja diseño.

25,5 x Ø7,1 cm 1 30

F(1), L2

-500	+500	+2000	+5000
4,40 €	4,20 €	4,10 €	3,98 €

stainless steel

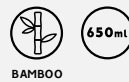

BOINA_ 4039

Bidón de acero inoxidable 304 y bambú.
Capacidad 650 ml. Presentación en caja diseño.

20,5 x Ø7,3 cm 1 50

F(1), L2, Q

-500	+500	+2000	+5000
5,52 €	5,32 €	5,06 €	4,82 €
5,92 €	5,72 €	5,46 €	5,22 €

COLOR BLANCO 01

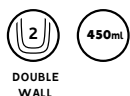

PALMER_ 4106

Termo de acero inoxidable 304 doble pared. Botón de apertura con cierre de seguridad. Capacidad 450 ml. Presentación en caja diseño.

23 x Ø6,4 cm 1 30

F(1), L2

-500	+500	+2000	+5000
7,60 €	7,26 €	6,96 €	6,60 €



01

251

02

new.



termosdoblecapa



new.

SUBLIMACIÓN



01

60

05

251

02

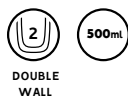

SALVIA_ 4123

Termo de acero inoxidable 304 con doble pared. Acabado brillo. Capacidad 500 ml. Presentación en caja diseño.

24,5 x Ø6,9 cm 1 30

F(1), L2, Q

-500	+500	+2000	+5000
7,56 €	7,36 €	7,06 €	6,82 €
7,76 €	7,56 €	7,26 €	7,02 €

COLOR BLANCO 01

DOUBLE
WALL**CELERY_ 4048**

Termo de acero inoxidable 304 con doble pared.
Acabado mate. Capacidad 500 ml. Presentación en
caja diseño.

24,5 x Ø6,9 cm 1 30

F(1), L2, Q

-500	+500	+2000	+5000	
8,80 €	8,40 €	8,00 €	7,70 €	
9,06 €	8,66 €	8,26 €	7,86 €	COLOR BLANCO 01

SUBLIMACIÓN



01

60

05

251

02

DOUBLE
WALLNATURAL
CORK

460ml

TAYOX_ 4056

Termo de acero 304 doble pared con infusor
de té y base de corcho. Capacidad 460 ml.
Presentación en caja diseño.

24,5 x Ø6,4 cm 1 30

F(1), L2

-500	+500	+2000	+5000
11,30 €	10,90 €	10,50 €	10,10 €



01

251

02

FILTRO



bidones de aluminio



YACA
4004

BAOBAB
4049

ATHLETIC
4045



01 60 05 226 02

BAOBAB_4049

800ml

Bidón de aluminio con mosquetón. Capacidad 800 ml. Presentación en caja diseño.

24,6 x Ø7,3 cm 1 50

F(1), L2, Q

-500	+500	+2000	+5000
3,36 €	3,26 €	3,16 €	3,06 €
3,56 €	3,46 €	3,36 €	3,26 €



01 60 05 226 251 02

ATHLETIC_4045

400ml

Bidón de aluminio con mosquetón. Capacidad 400 ml. Presentación en caja diseño.

17,5 x Ø6,6 cm 1 50

F(1), L2, Q

-500	+500	+2000	+5000
2,46 €	2,36 €	2,30 €	2,20 €
2,72 €	2,62 €	2,56 €	2,46 €



01 03 60 05 226 02

YACA_4004

330ml

Bidón de aluminio con mosquetón de color a juego. Capacidad 330 ml. Presentación en caja diseño.

15 x Ø6,6 cm 50 100

F(1), L2

-500	+500	+2000	+5000
2,28 €	2,18 €	2,12 €	2,06 €



60

05

251

23



550ml

LONGAN_ 4031

Vaso de acero inoxidable de 550 ml con tapa transparente. Presentación en caja diseño.

17,1 x Ø8,8 cm 1 30

F(1), L2

-500	+500	+2000	+5000
4,56 €	4,36 €	4,16 €	3,96 €



01

60

05

251

02



310ml

SALAK_ 4028

Vaso de acero inoxidable de 310 ml con tapa en PP. Presentación en caja diseño.

16,7 x Ø7,2 cm 1 50

F(1), L2

-500	+500	+2000	+5000
3,06 €	2,96 €	2,84 €	2,76 €

100%
acero
inoxidable



01

31

60

05

226

251

02



290ml

MILU_ 4029

Vaso de acero inoxidable de 290 ml con tapa en PP. Presentación en caja diseño.

14,4 x Ø7,3 cm 1 50

F(1), L2

-500	+500	+2000	+5000
3,76 €	3,56 €	3,40 €	3,26 €



LULO_4025

Taza de PP térmico con tapa. Cuerpo a color. Capacidad 470 ml.

16 x Ø8,5 cm 1 25

F(1)

-500	+500	+2000	+5000
2,20 €	2,08 €	1,98 €	1,88 €



MAMEY4026

DURIAN4027



MAMEY_4026

Vaso de acero inoxidable de 450 ml de capacidad. Presentación en caja blanca.

18,8 x Ø8,7 cm 1 50

F(1), L2

-500	+500	+2000	+5000
2,70 €	2,65 €	2,55 €	2,48 €



DURIAN_4027

Taza de acero inoxidable con asa de PP. 450 ml de capacidad. Presentación en caja blanca.

17,6 x Ø8,7 cm 1 50

F(1), L2

-500	+500	+2000	+5000
2,99 €	2,94 €	2,84 €	2,74 €

100% RPET

Hechos a partir de
plásticos reciclados



600ml

VALSAN_4067

Bidón de RPET con cuerpo en color translúcido.
Capacidad 600 ml. Cinta de transporte incluida.
Presentación en caja diseño eco.

21,5 x Ø6,5 cm 1 50

F(1), L2

-500	+500	+2000	+5000
3,00 €	2,86 €	2,76 €	2,60 €



00



31



60



226



05



02

botellas de tritán



01 02 226 60 05 03



KINKAN_ 4038

Bidón de tritán con cuerpo en color translúcido. Tapón a juego con asa de transporte integrada. Capacidad 680 ml. Presentación en caja diseño.

25,7 x Ø6,7 cm 1 50

F(1)

-500	+500	+2000	+5000
2,94 €	2,84 €	2,74 €	2,58 €



01 60 05 226 02



ALOE_ 4044

Bidón de tritán de 600 ml. Tapón con cinta de transporte a color. Presentación en caja diseño.

22,5 x Ø6,6 cm 1 50

F(1)

-500	+500	+2000	+5000
3,25 €	3,15 €	3,04 €	2,90 €



01

03

60

05

226

251

02

CHITO_ 4058

680ml

Bidón de aluminio con cuerpo en acabado sólido. 680 ml de capacidad. Tapón con boquilla retráctil y asa de transporte. Presentación en caja diseño.

22,1 x Ø7,3 cm 1 50

F(1), L2

-500	+500	+2000	+5000
3,44 €	3,30 €	3,16 €	3,00 €



sports bottles



00

60

05

226



700ml

EDDO_ 4041

Bidón de 700 ml en acabado AS transparente. Tapón y base de acero inoxidable. Presentación en caja diseño.

26,5 x Ø7,1 cm 1 30

F(1), L2

-500	+500	+2000	+5000
2,38 €	2,30 €	2,18 €	2,10 €

softflask



new.



TRAIL_ 4104

Bidón plegable realizado en TPU flexible. Incluye asa de transporte. Ideal para eventos deportivos. Capacidad 500 ml.

25 x 9 cm 50 400

F(1)

-500	+500	+2000	+5000
4,28 €	4,18 €	4,08 €	3,98 €



new.



TRACK_ 4119

Vaso plegable ideal para eventos deportivos realizado en TPU flexible. Capacidad 230 ml.

10,7 x Ø7,1 cm 100 600

F(1)

-500	+500	+2000	+5000
3,24 €	3,14 €	3,04 €	2,94 €



MANDY_ 4086

Bidón de PET flexible con forma de camiseta. Tapón de seguridad y mosquetón de transporte. 470 ml de capacidad.

17 x 25,5 x 3,3 cm 50 400

E(1)

-500	+500	+2000	+5000
0,940 €	0,890 €	0,840 €	0,800 €



01 03 31 60 05 226 02



520ml

RUNNING_ 4046

Bidón deportivo de PE. Capacidad 520 ml.

19,5 x Ø6,5 cm 10 100

F(1)

-500	+500	+2000	+5000
1,26 €	1,22 €	1,18 €	1,14 €



Sport bottles



01 03 31 60 05 226 02



840ml

KUMAT_ 4036

Bidón deportivo de PE con 840 ml de capacidad.

23,5 x Ø7,5 cm 10 100

F(1)

-500	+500	+2000	+5000
1,81 €	1,76 €	1,71 €	1,69 €



01 03 31 60 05 226 02



620ml

BIKING_ 4047

Bidón deportivo de PE con amplia superficie para marcaje. Capacidad 620 ml.

20,5 x Ø7,5 cm 10 100

F(1)

-500	+500	+2000	+5000
1,51 €	1,46 €	1,41 €	1,39 €





00 03 31 60



05 226 02 40

500ml

ALFE_ 4037

Bidón de cristal con cuerpo a color. Capacidad 500 ml. Incluye cinta de transporte. Presentación en caja diseño.

22 x Ø6,3 cm 1 50

F(1), L2

-500	+500	+2000	+5000
2,06 €	1,96 €	1,90 €	1,80 €



00 31 60



05 226 02

650ml

SANDI_ 4099

Bidón de cristal con cuerpo en color translúcido. Tapón de acero inoxidable. Capacidad 650 ml. Presentación en caja diseño.

26 x Ø7,1 cm 1 30

F(1), L2

-500	+500	+2000	+5000
3,76 €	3,38 €	3,26 €	3,14 €



botellas de cristal



BAMBOO

TRILBY_ 4020

Bidón de cristal de 450 ml con tapón de bambú y cintra de transporte en acabado natural. Presentación en caja diseño eco.

19,7 x Ø6,4 cm 1 50

F(1), L2

-500	+500	+2000	+5000
3,10 €	2,98 €	2,85 €	2,70 €

SUBLIMACION



01 03 31 60



05 226 02 40

500ml

CAMU_ 4040

Bidón de cristal de 500 ml. Funda y cinta de transporte a color. Presentación en caja diseño.

22 x Ø6,7 cm 1 40

F(1), N(8), L2, Q

-500	+500	+2000	+5000
2,18 €	2,14 €	2,08 €	1,96 €



SUBLIMACION



01 03 31 60



05 226 02 40

600ml

KASTER_ 4098

Bidón de cristal de 600 ml. Incluye funda a color con asa para transporte. Presentación en caja diseño.

16,2 x Ø8,8 cm 1 40

F(1), N(8), L2, R

-500	+500	+2000	+5000
2,94 €	2,80 €	2,70 €	2,60 €



01 60 05 226 02



BAMBOO

540ml

NAGAMI_ 4055

Bidón de cristal con tapón de bambú y funda de silicona en color. Capacidad 540 ml. Presentación en caja diseño.

23,1 x Ø6,7 cm 1 30

G(1), L2

-500	+500	+2000	+5000
5,90 €	5,64 €	5,32 €	5,04 €





**HOME
GIFTS &
PREMIUM**



set quesos

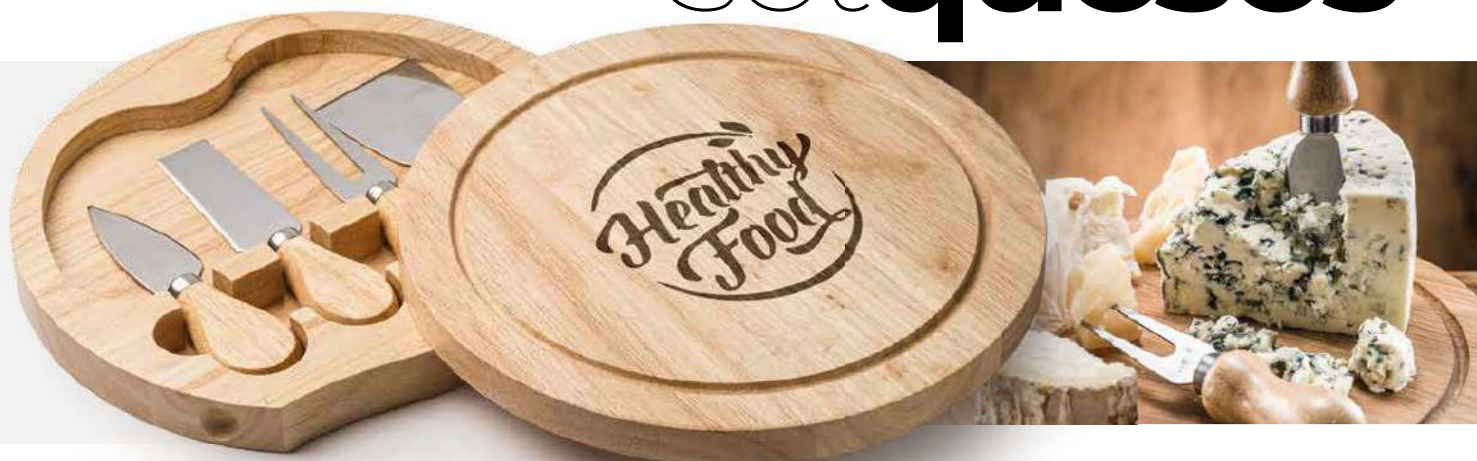

4 ACCESORIOS



COMTE_4102

Set para quesos con 4 utensilios de acero inoxidable y mango de madera. Presentados en práctico estuche de madera con tabla para cortar en la zona superior. Presentación en caja blanca.

3,6 x Ø22 cm 1 10

E(1), L2

-500	+500	+2000	+5000
15,40 €	15,20 €	15,00 €	14,70 €



new.



BAMBOO

ALGOR_4113

Set de 4 posavasos de bambú natural. Presentación en caja eco.

11,2 x 11,2 x 3,6 cm 1 20

E(1), L2

-500	+500	+2000	+5000
4,94 €	4,78 €	4,54 €	4,32 €



new.



BAMBOO

ANGUS_4116

Tabla de cortar de bambú natural con perfil recoge líquidos. Presentación en caja eco.

30 x 1,2 x 20 cm 1 20

E(1), L2

-500	+500	+2000	+5000
5,44 €	5,14 €	4,90 €	4,70 €



new.



BAMBOO

DEVON_ 4114

Tabla de cortar de bambú natural. Troquelado para colgar y fácil manejo. Presentación en caja eco.

15,3 x 1 x 20 cm 1 50

E(1), L2

-500	+500	+2000	+5000
2,14 €	2,10 €	2,00 €	1,90 €



BAMBOO

RABIL_ 3028

Báscula de cocina digital con carcasa frontal de bambú natural. Capacidad máxima de 5 kg. Funciona con 1 pila de botón incluida. Presentación en caja diseño eco.

15 x 1,6 x 21,5 cm 10 20

E(1), L2, W

-500	+500	+2000	+5000
12,38 €	11,92 €	11,34 €	10,88 €

new **rabil**

new.



DEVON4114

ANGUS4116

BORAN4115



EDAM_ 4101

Set para quesos con 4 utensilios de acero inoxidable y mango de madera. Presentados en un elegante estuche con interior acolchado.

21,5 x 3,4 x 17,4 cm  10  40

F(1), L1

-500	+500	+2000	+5000
7,40 €	7,16 €	6,86 €	6,60 €



BAMBOO

BORAN_ 4115

Tabla de cortar de madera con mango para fácil manejo y cuerda para colgar. Presentación en caja eco.

13,5 x 1 x 40 cm  1  30

E(1), L2

-500	+500	+2000	+5000
5,38 €	5,14 €	4,96 €	4,74 €



new.

SHERRY_ 4088

Abridor imantado de bambú con función posavasos.

1,1 x Ø6 cm 50 500

D(4), L1

-500	+500	+2000	+5000
1,47 €	1,41 €	1,35 €	1,29 €

**RODEN_ 4090**

Abridor de acero inoxidable con empuñadura de madera natural.

14,4 x 2,2 x 4 cm 50 200

D(4), L1, W

-500	+500	+2000	+5000
1,20 €	1,16 €	1,10 €	0,970 €

abridores

new.

**SHAKE_ 4078**

Abridor de diseño realizado en madera natural con interior de acero inoxidable y troquel redondo para colgar.

17,9 x 4,1 cm 50 100

D(4), L1, W

-500	+500	+2000	+5000
2,48 €	2,38 €	2,28 €	2,18 €

COLINS_ 4111

BAMBOO

Abridor de diseño compacto realizado en bambú natural con interior de acero inoxidable y troquel superior para colgar.

10,5 x 1 x 4 cm 50 200

D(4), L1

-500	+500	+2000	+5000
2,28 €	2,18 €	2,08 €	1,98 €

BAMBU

CHALA4087

VENET4091



CORCHO NATURAL



CHALA_ 4087

Posavasos de corcho natural.

0,3 x Ø10 cm 500 1000

D(1), L2

-500	+500	+2000	+5000
0,190 €	0,186 €	0,180 €	0,170 €



NATURAL CORK

VENET_ 4091

Set de vino con accesorios en acero inox, sacacorchos 2 tiempos con cortacápsulas, recogebotas y dosificador. Presentado en estuche de corcho natural con interior acolchado.

4,2 x Ø14,9 cm 1 20

G(1), L2

-500	+500	+2000	+5000
10,74 €	10,34 €	9,90 €	9,44 €



4 ACCESORIOS

Setvino

HOME GIFT & PREMIUM

new.



4 ACCESORIOS



MALBEC_4112

Set de vino con accesorios de acero inoxidable, sacacorchos con cortacápsulas, recogegotas, tapón y dosificador. Presentado en caja de metal con interior acolchado.

18 x 4 x 11 cm 1 20

G(1), L2

-500	+500	+2000	+5000
7,98 €	7,60 €	7,10 €	6,80 €

merlot

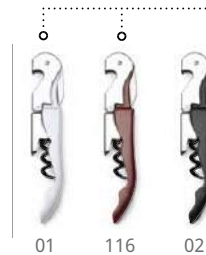

newcolors

MERLOT_4075

Sacacorchos de estilo clásico en acero inoxidable con dos posiciones. Presentación en caja blanca.

12 x 2,1 x 1,3 cm 10 200

E(1), L1

-500	+500	+2000	+5000
1,16 €	1,12 €	1,08 €	1,00 €

new.



GARNAC_4118

Sacacorchos de estilo clásico en acero inox. Con cortacapsulas y abridor. Presentación en caja blanca.

11 x 1,2 x 2,2 cm 10 200

D(1)

-500	+500	+2000	+5000
1,42 €	1,34 €	1,28 €	1,20 €



SYRAH_4076

Sacacorchos metálico con forma de botella en plástico PS. Presentación en caja blanca.

12 x Ø2,5 cm 50 200

D(1)

-500	+500	+2000	+5000
0,990 €	0,950 €	0,920 €	0,880 €

recycledcotton



organiccotton



29 60 05 226 02



AROLA_ 9136

Delantal realizado en algodón reciclado con acabado jaspeado. Bolsillo frontal. Talla única ajustable.

93 x 65 cm 10 100

E(4), N(8), P

-500	+500	+2000	+5000
3,98 €	3,82 €	3,68 €	3,52 €



OLIVER_ 9135

Delantal 100% algodón orgánico con bolsillo frontal. Talla única ajustable.

93 x 65 cm 10 100

E(4), N(8), P

-500	+500	+2000	+5000
4,66 €	4,46 €	4,30 €	4,10 €



new.

PARTE LISA PARA MARCAJE



MAURO_ 9138

Manopla 100% de algodón orgánico. Una cara lisa ideal para marcaje y cinta para colgar.

30,5 x 19 cm 25 200

E(1), N(8)

-500	+500	+2000	+5000
2,78 €	2,66 €	2,54 €	2,44 €



new.

PARTE LISA PARA MARCAJE



ENEKO_ 9137

Set de cocina compuesto por agarrador y manopla en suave algodón/poliéster. Una cara lisa ideal para marcaje y cinta para colgar.

30,5 x 19 cm 10 100

E(1), N(8)

-500	+500	+2000	+5000
2,98 €	2,84 €	2,74 €	2,58 €



new.

SUBLIMACIÓN



ROGER_ 9134

Manopla de cocina en poliéster. Acabado en color blanco con bordes y cinta para colgar en color. Cara lisa ideal para sublimación.

30,5 x 19 cm 50 200

E(1), N(8), R

-500	+500	+2000	+5000
2,04 €	1,96 €	1,86 €	1,78 €



ROCA_ 9132

Manopla de cocina en suave algodón / poliéster con una cara lisa para marcaje.

19 x 30,5 cm 25 200

E(1), N(8)

-500	+500	+2000	+5000
1,74 €	1,66 €	1,58 €	1,50 €

AROLY



AROLY



01 03 31 60



05 226 02 40

DUCASSE_9129

Delantal largo con doble bolsillo frontal y tiras a juego. 90% poliéster y 10% algodón de 150 g/m². Etiqueta removible. Talla única.

65 x 90 cm 10 100

Consultar

Caja	Pack	Unidad
3,300 €	3,465 €	3,960 €



01 60



05 02

RAMSAY_9128

Delantal largo con tiras del cuello y cintura a juego. 80% poliéster y 20% algodón de 190 g/m². Etiqueta removible. Talla única.

65 x 90 cm 50 100

Consultar

Caja	Pack	Unidad
3,200 €	3,360 €	3,840 €

**JAMIE_ 9133**

Set infantil de delantal y gorro, realizado en non-woven de 80 g/m². Talla única ajustable. Medidas del bolsillo del delantal: 17 x 17 cm.

Consultar 10 300
 E(1)

-500	+500	+2000	+5000
1,12 €	1,09 €	1,05 €	1,01 €

**KELLER_ 9130**

Delantal de non-woven a color con bolsillo central. Talla única ajustable. Medidas del bolsillo: 22 x 17 cm.

50 x 73 cm 10 200
 E(1)

-500	+500	+2000	+5000
0,930 €	0,890 €	0,850 €	0,810 €

**PACHU_ 9131**

Delantal infantil de non-woven con diseño para colorear. 5 ceras en varios colores incluidas. Talla única ajustable.

43 x 43 cm 50 200
 F(1)

-500	+500	+2000	+5000
0,800 €	0,770 €	0,750 €	0,710 €

VOLEN_ 1000

Maceta con semillas de petunia y macetero biodegradable. Incluye sustrato.

6,1 x Ø6,4 cm 25 200

E(4)

-500	+500	+2000	+5000
1,72 €	1,66 €	1,60 €	1,54 €

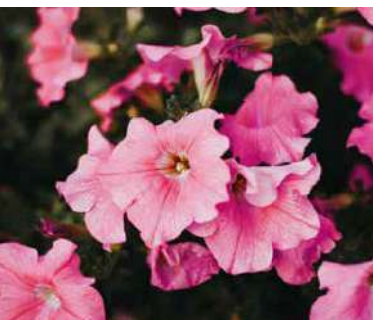

macetero biodegradable



01 260 60



251 02

KIMI_ 1311

Vela aromática en vaso de cristal de colores y fragancias variadas (café, pino, lavanda, vainilla y fresa). Presentada en caja individual.

6,7 x Ø5,6 cm 1 50

F(1), L2

-500	+500	+2000	+5000
1,90 €	1,80 €	1,72 €	1,64 €



01 60 40 31



05 03 02 226

FLAKE_ 1306

Vela aromática en vivos colores presentada a juego con porta-velas metálico. Tapa con ventana transparente.



3 x Ø6,3 cm 50 250

E(1), L1

-500	+500	+2000	+5000
1,28 €	1,22 €	1,17 €	1,11 €

KING_ 1307

Vela aromática con porta-velas pizarra de cerámica.
Incluye tiza blanca. Presentación en caja de cartón Kraft.

 7,8 x Ø7 cm  1  50

 E(1), L2

-500	+500	+2000	+5000
2,50 €	2,40 €	2,32 €	2,02 €



velas para todos



512



511

MAKA_ 1312

Vela en soporte de madera con diseños navideños
(estrella y árbol). Presentación en caja individual.

 512: 8,7 x 8,4 x 2,1 cm / 511: 9,4 x 9,4 x 2,1 cm

 100  200  E(1), L1

-500	+500	+2000	+5000
1,90 €	1,84 €	1,78 €	1,70 €



**ROCKS_ 1009**

Set de 3 juegos de habilidad en madera natural. Presentado en caja de madera con tres compartimentos y tapa deslizante.

16,5 x 6 x 6,4 cm 1 50

D(4), L2, W

-500	+500	+2000	+5000
6,50 €	6,26 €	5,98 €	5,70 €

**BRISCA_ 1016**

Set de 2 juegos de mesa: baraja francesa y dados. Presentado en caja de madera con dos compartimentos y tapa deslizante.

10 x 2,5 x 9,1 cm 50 100

D(4), L2, W

-500	+500	+2000	+5000
2,04 €	1,96 €	1,88 €	1,78 €

disfruta jugando

RYMAN_ 1010

Juego de habilidad formado por 45 bloques rectangulares, presentado en bolsa de algodón con cordones.

5,7 x 16,5 x 5,7 cm 1 50

G(1), N(8)

-500	+500	+2000	+5000
3,30 €	3,20 €	3,04 €	2,94 €



**GALVY_ 1014**

Set de 4 juegos de habilidad: mikado, ajedrez, damas y dominó. Presentado en caja con tapa deslizante con función tablero en su interior.

16,6 x 3 x 16,5 cm

1

50

E(2), L2, W

-500	+500	+2000	+5000
4,56 €	4,46 €	4,30 €	4,20 €

**TRIWA_ 1011**

Juego de mesa 3 en raya realizado en madera. 9 bloques presentados en caja con tapa deslizante.

7,5 x 3,2 x 7,5 cm

50

200

D(4), L2, W

-500	+500	+2000	+5000
1,64 €	1,58 €	1,50 €	1,43 €

**DOMIS_ 1013**

Juego de dominó realizado en madera. 28 piezas presentadas en caja con tapa deslizante.

14,6 x 3 x 5 cm

50

100

E(2), L2, W

-500	+500	+2000	+5000
1,10 €	1,06 €	1,02 €	1,00 €



LEIS_ 0111

Puzzle Tangram de madera natural con 7 piezas a color.

10,3 x 0,7 x 10,3 cm 100 400

E(1), L2

-500	+500	+2000	+5000
0,360 €	0,350 €	0,340 €	0,330 €



60 29 226 05 03 01

ROSKO_ 0112

Yoyo de madera natural con cordón de 75 cm.

2,8 x Ø5,5 cm 50 400

C(4), W, L1

-500	+500	+2000	+5000
0,590 €	0,570 €	0,550 €	0,510 €



TURCAZ_ 7530

Mochila infantil de cordones realizada en non-woven, con diseño para colorear. Incluye 5 ceras en colores variados.

25 x 30 cm 50 200

G(1)

-500	+500	+2000	+5000
0,490 €	0,470 €	0,450 €	0,430 €



AZOR_ 7529

Bolsa infantil de non-woven con diseño para colorear. Incluye 5 ceras en colores variados.

20,5 x 22 cm 50 100

F(1)

-500	+500	+2000	+5000
0,330 €	0,320 €	0,310 €	0,290 €

**LILIAN_8047**

Pizarra y rotulador magnéticos en variados colores. Rotulador de tinta negra con borrador incluido.

10,5 x 15 cm 25 200

D(4)

-500	+500	+2000	+5000
0,570 €	0,550 €	0,530 €	0,510 €

RESOL_8069

Set infantil para colorear. Incluye bloc con dibujos variados, 6 lápices de colores, sacapuntas y goma de borrar. Práctica asa de transporte.

20 x 21 x 1,6 cm 40 80

D(1)

-500	+500	+2000	+5000
2,58 €	2,54 €	2,42 €	2,32 €

new.



new.

**PYRUS_8077**

Set infantil para colorear. Incluye bloc con dibujos variados. 12 lápices de colores.

10 x 1 x 9,5 cm 50 200

C(4)

-500	+500	+2000	+5000
1,98 €	1,94 €	1,82 €	1,72 €

36 LÁMINAS

TILOS_8049

Set infantil para colorear. Incluye bloc con dibujos, 6 lápices de colores y sacapuntas. Presentación en caja de cartón reciclado.

7,4 x 1,5 x 9 cm 50 400

C(4), W

-500	+500	+2000	+5000
0,430 €	0,410 €	0,400 €	0,380 €



DIBUJOS PARA COLOREAR

soportes para móvil



BAMBOO

STELO_ 4094

Llavero con función soporte para el móvil realizado en bambú.

8 x 14,6 x 2,6 cm

100

500

D(4), L1, W

-500	+500	+2000	+5000
0,930 €	0,890 €	0,850 €	0,830 €



BAMBOO

BONCER_ 4110

Llavero de bambú natural con función de soporte para móvil.

8,5 x 0,8 x 2,9 cm

100

600

D(4), L1

-500	+500	+2000	+5000
0,980 €	0,960 €	0,940 €	0,890 €



new.



BAMBOO

LYRA_ 3010

Soporte de bambú natural para móviles. Ranura inferior para cable de carga. Incluye 2 partes de fácil montaje.

8 x 8,1 x 12 cm

50

100

D(4), L2, W

-500	+500	+2000	+5000
1,98 €	1,88 €	1,80 €	1,72 €



BAMBOO

ANTIX_ 3055

Soporte para dispositivos móviles, tablet o smartphone, realizado en bambú natural.

6 x 2 x 8 cm

50

200

D(4), L2, W

-500	+500	+2000	+5000
1,32 €	1,28 €	1,24 €	1,18 €

new.



982

983

MARBEL_ 4109

Llavero de madera natural en dos formatos con terminaciones en elegante polipiel.

8,5 x 0,5 cm 100 800

D(4), L1

-500	+500	+2000	+5000
0,500 €	0,480 €	0,460 €	0,440 €

BUDAN_ 4054

Llavero de madera natural. Especial para grabado láser.

10,4 x Ø5 cm 200 800

D(4), L1

-500	+500	+2000	+5000
0,320 €	0,310 €	0,300 €	0,290 €

0,5 x Ø5 cm



982

983

6 x 0,3 x 3,5 cm



4 x 0,5 x 6 cm

981

0,5 x Ø5 cm

982

NATURAL
CORK**HIBIS_ 4053**

Llavero de corcho natural.

3,9 x 8,1 x 0,6 cm 200 800

D(1), L1

-500	+500	+2000	+5000
0,478 €	0,448 €	0,428 €	0,408 €

SILA_ 4092

Llavero de madera natural en dos formatos con anilla metálica. Ideal para marcaje en láser.

7,2 x 0,6 cm 100 1000

D(4), L1

-500	+500	+2000	+5000
0,380 €	0,370 €	0,360 €	0,350 €



3 x 8,8 x 0,6 cm

Ø3,9 x 0,6 cm

new.



02

05

NATURAL
CORK**YATE_ 4108**

Llavero de corcho flotante con resistente cuerda en poliéster.

9 x 1,5 x 4 cm 50 400

D(4), L1

-500	+500	+2000	+5000
1,76 €	1,64 €	1,56 €	1,46 €

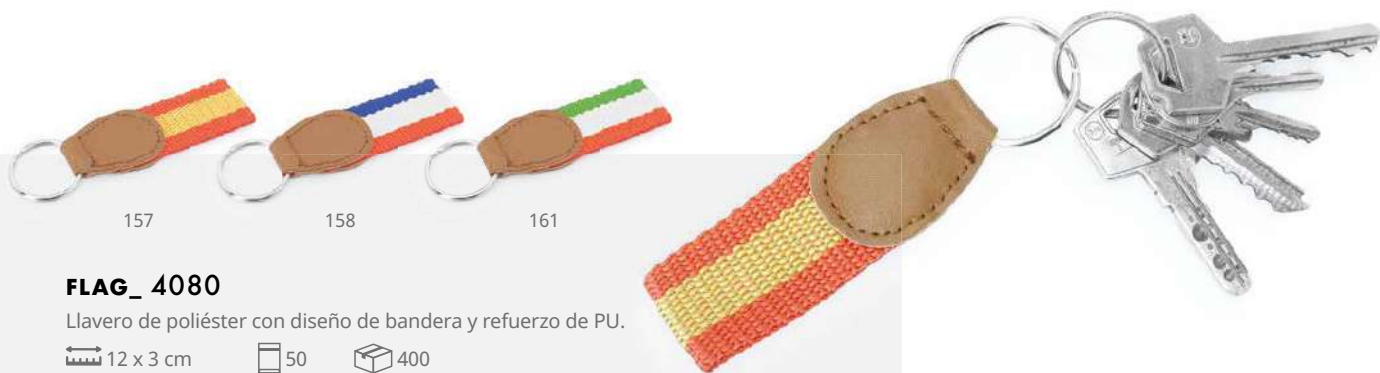

157

158

161

FLAG_ 4080

Llavero de poliéster con diseño de bandera y refuerzo de PU.

12 x 3 cm

50

400

E(1), L1

-500	+500	+2000	+5000
0,380 €	0,360 €	0,340 €	0,330 €



01

03

31

55

05

226

02

60

MINERAL_ 4051

Llavero metálico con tira de color en poliéster.

2,8 x 6,5 x 0,6 cm

50

300

D(4), L1

-500	+500	+2000	+5000
0,820 €	0,800 €	0,780 €	0,760 €



03

01

60

226

05

SITO_ 4079

Llavero de osito de peluche realizado en suave poliéster con camiseta a color.

6,5 x 7,5 x 4 cm

20

500

E(1), N(8)

-500	+500	+2000	+5000
1,62 €	1,53 €	1,46 €	1,39 €



01 60 05 02

anti**bacterial**
ISO 22196**DALTON_4089**

Llavero anti-contacto realizado en ABS con tratamiento anti-bacterias.

4 x 7 x 0,4 cm
 50
 1000

C(4)

-500	+500	+2000	+5000
0,350 €	0,330 €	0,310 €	0,290 €



ABRIDOR



60 05 251 02

ROSS_4052

Llavero anti-contacto multifunción de aluminio. Evite tocar cualquier superficie: pulsador, abre puertas, abridor, etc.

6,6 x 2,7 x 0,3 cm
 100
 1000

D(4), L1

-500	+500	+2000	+5000
0,410 €	0,390 €	0,370 €	0,340 €



60 05 226 251 02

PALE_4073

Llavero mosquetón de aluminio.

3 x 5,8 x 0,5 cm
 200
 1000

D(1), L1

-500	+500	+2000	+5000
0,200 €	0,190 €	0,180 €	0,170 €



01 05 226 02 60

TONIC_4050

Llavero con moneda para carro de la compra. Metálico con esmalte a color.

6 x Ø2,3 cm
 100
 1000

D(1)

-500	+500	+2000	+5000
0,480 €	0,460 €	0,450 €	0,420 €



05 226 251 02 40 60

SPARKLING_ 4070

Llavero abridor de aluminio.

1,1 x 6,7 x 1,5 cm

200

1000

D(4), L1

-500	+500	+2000	+5000
0,210 €	0,190 €	0,180 €	0,170 €



60 226 251 02 05

LAGER_ 4072

Abridor de aluminio de diseño clásico.

3,8 x 8,5 x 0,3 cm

100

1000

D(4), L1

-500	+500	+2000	+5000
0,340 €	0,330 €	0,320 €	0,300 €



226 60 05 251 02

STOUT_ 4071

Llavero abridor de aluminio con forma de botella.

3 x 8,9 x 0,2 cm

100

1000

D(4), L1

-500	+500	+2000	+5000
0,520 €	0,500 €	0,470 €	0,440 €



60 05 226 251 02 31

MALT_ 4074

Llavero abridor de aluminio.

0,9 x 7,9 x 1,5 cm

200

1000

D(4), L1

-500	+500	+2000	+5000
0,320 €	0,310 €	0,300 €	0,280 €

**TRESNA_ 1004**

Llavero flexómetro de 1 metro con mecanismo de bloqueo y cuchilla metálica.

4,3 x 4,4 x 1,8 cm

50

500

D(1), V

-500	+500	+2000	+5000
0,580 €	0,560 €	0,540 €	0,520 €

**SEYKU_ 1228**

Pelota anti-estrés realizada en PU de color liso.

Ø6,2 cm

20

400

E(1)

-500	+500	+2000	+5000
0,610 €	0,590 €	0,580 €	0,550 €



antiestrés

BIKU_ 1229

Corazón anti-estrés realizado en PU de color liso.

7 x 7 x 4 cm

20

400

E(1)

-500	+500	+2000	+5000
0,740 €	0,710 €	0,690 €	0,660 €





**TOOLS &
PETS CARE**





FRANKLIN_ 9921

Gafas transparentes anti-vaho. Patillas con ventilación lateral, realizadas en ligero policarbonato.

15,5 x 5,7 x 15 cm 10 200
D(4)

-500	+500	+2000	+5000
2,78 €	2,68 €	2,58 €	2,38 €



01 03 60 05 226

LOCK_ 0108

Cutter de cuchilla ancha y cuerpo de ABS. Agarre ergonómico troquelado y capucha extraíble para el corte y ajuste de la cuchilla.

3 x 15,5 x 1,4 cm 100 500
C(4)

-500	+500	+2000	+5000
0,370 €	0,360 €	0,350 €	0,330 €

your favo



5M

PICK



3M

RIVET



03 01 05 60 226

PICK_ 0106

Fléxometro de 5 metros homologado, con mecanismo de bloqueo y cuchilla metálica. Cuerpo en color con funda de goma, clip metálico y cinta de transporte. Presentación en caja individual.

7 x 3,5 x 7 cm 10 50
E(1)

-500	+500	+2000	+5000
2,30 €	2,20 €	2,10 €	1,94 €



03 01 05 60 226

RIVET_ 0105

Fléxometro de 3 metros homologado, con mecanismo de bloqueo y cuchilla metálica. Cuerpo en color con funda de goma, clip metálico y cinta de transporte. Presentación en caja individual.

6,5 x 3 x 6 cm 10 50
E(1)

-500	+500	+2000	+5000
1,38 €	1,34 €	1,30 €	1,26 €



9 FUNCIONES



BAMBOO

BINTAL_ 4096

Navaja multiusos con accesorios en acero inox y con cuerpo de bambú. 9 funciones. Incluye cinta para transporte en polipiel. Presentación en caja eco.

9 x 1,6 x 2,3 cm 50 100

E(4), L1

-500	+500	+2000	+5000
4,34 €	4,18 €	4,04 €	3,88 €

urite tools

ZORA_ 4095

Navaja multiusos de acero inox. con 6 funciones: cuchillo, abridor, abrelatas, descorchador, destornillador y llavero. Presentación en caja blanca.

7,6 x 2,1 x 0,7 cm 20 200

E(4), L1

-500	+500	+2000	+5000
1,61 €	1,55 €	1,49 €	1,43 €



6 FUNCIONES

new.



BAMBOO

MURDOK_ 4120

Multiherramienta con cuerpo y accesorios en acero inoxidable y empuñadura de bambú. 12 funciones: navaja, sierra, limas, abridores, destornilladores y alicates. Incluye cinta para transporte. Presentación en caja eco.

5 x 1,7 x 10,5 cm 10 100

E(4), L1

-500	+500	+2000	+5000
8,30 €	8,00 €	7,70 €	7,40 €



01

02

SHERLOCK_ 0104

Lupa cuentahilos plegable de 8 aumentos, con regla de medición integrada en el cuerpo. Presentación en caja individual.

4,5 x 4,5 x 1,4 cm 50 400

C(4)

-500	+500	+2000	+5000
1,98 €	1,86 €	1,78 €	1,72 €

sherlock

new.



29 60 05 02

VETA_ 8088

Lápiz de carpintero en forma ovalada para un fácil marcaje. Punta sin afilar.

17,6 x 1,2 cm 100 1000

A(4)

-500	+500	+2000	+5000
0,166 €	0,156 €	0,146 €	0,136 €



MATA_ 8003

Mini lápiz de madera en acabado natural con goma. Cuerpo redondo.

10 x Ø0,5 cm 100 2000

A(4)

-500	+500	+2000	+5000
0,034 €	0,033 €	0,032 €	0,031 €



KANCHAN_ 8024

Bolígrafo multiherramientas 4 en 1: nivel, regla en centímetros y pulgadas, destornillador con cabeza plana y estrella. Cuerpo con acabado metalizado, mecanismo giratorio y clip metálico. Tinta azul.

14,9 x Ø1 cm 50 1000

B(4)

-500	+500	+2000	+5000
0,860 €	0,820 €	0,780 €	0,750 €

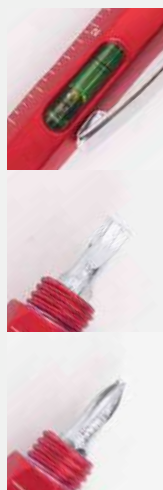

01 60 02 05 251



LUZ 3 POSICIONES



01 60 05 226 02



FLASH_ 0110

Linterna deportiva multiusos con cinta para ajuste. 8 luces LED COB con 3 modos de iluminación. 3 Pilas AAA no incluidas. Presentación en caja individual.

6,1 x 4 x 1,7 cm 100 500

E(1)

-500	+500	+2000	+5000
1,27 €	1,22 €	1,16 €	1,11 €



60 05 251 02

ARAYA_ 8023

Bolígrafo linterna de luz LED con cuerpo de ABS metalizado. Mosquetón integrado en la capucha. Tinta azul.

11 x Ø1 cm 50 500

B(4)

-500	+500	+2000	+5000
0,670 €	0,640 €	0,610 €	0,570 €



CARGA MANUAL



03 60 05 226 02

BRILL_ 0107

Linterna con 3 luces LED y carga manual. Disponible en varios colores translúcidos, con cinta de transporte en color gris a juego con el pulsador. Presentación en caja individual.

10,5 x 5 x 2,5 cm 25 200

E(4)

-500	+500	+2000	+5000
1,60 €	1,53 €	1,46 €	1,39 €



60 05 251 02

HALE_ 0109

Linterna de aluminio en acabado metalizado con 1 LED. Mosquetón de transporte a juego y pilas de botón incluidos.

6 x Ø1,5 cm 100 600

D(4), L1

-500	+500	+2000	+5000
0,860 €	0,840 €	0,810 €	0,780 €

always with light

TURNER_ 4127

Set de herramientas con 20 accesorios. Cutter, llaves hexagonales, destornilladores de estrella y planos y herramienta de fijación.

4,9 x Ø12,9 cm 1 30

F(2)

-500	+500	+2000	+5000
8,30 €	7,90 €	7,50 €	7,30 €



new.

new nisek

new.



01

60

05

02

NISEK_ 4128

Rascador de hielo con manopla forrada en poliéster 210T.

25 x 1,5 x 17 cm 1 20 100

E(1), N(8)

-500	+500	+2000	+5000
1,90 €	1,76 €	1,68 €	1,58 €



RIFTER_ 7169

Organizador de maletero para coche en resistente non-woven. Asas de transporte reforzadas, asas laterales y bolsillo frontal. Base rígida para un mejor ajuste.

34 x 28 x 25 cm 1 40

F(1), N(8)

-500	+500	+2000	+5000
4,18 €	4,02 €	3,82 €	3,72 €

new.





new.

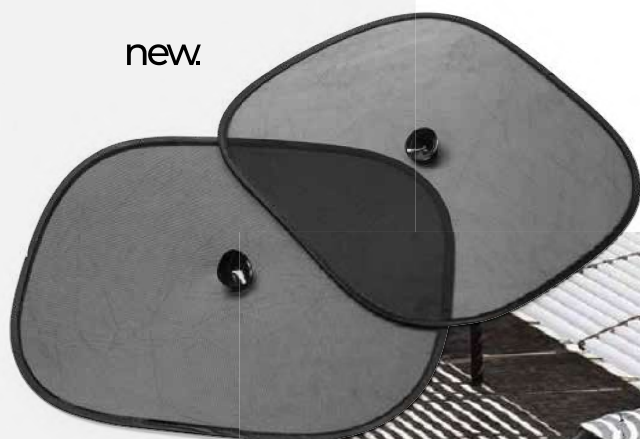

MACK_ 1007

Set de 2 parasoles plegables para ventanilla. Incluye ventosas de sujeción. Presentación en funda de PVC.

44 x 38 cm 50 200

F(1)

-500	+500	+2000	+5000
1,18 €	1,16 €	1,10 €	1,08 €

mack

parasoles



BORA_ 0103

Cubre volante redondo con capa frontal en aluminio metalizado. Ribete en color negro. Presentación en plano.

Ø44 cm 200

F(1)

-500	+500	+2000	+5000
1,10 €	1,06 €	1,02 €	0,98 €

150 X 70 CM

new.



PRISMA_ 1008

Parasol plegable de poliéster 170T. Incluye práctica funda a juego.

150 x 70 cm 50 100

G(1)

-500	+500	+2000	+5000
3,30 €	3,20 €	3,08 €	2,98 €

INCLUYE FUNDA



new.



180 X 90 CM

COLUMBIA_ 1017

Parasol de grandes dimensiones ideal para camiones y furgonetas. Burbuja a doble cara, realizado en aluminio acabado metalizado y ribete en negro. Incluye argollas metálicas con ventosas y cintas elásticas para plegado. Presentación en plano.

 180 x 90 cm  50

 G(1)

-500	+500	+2000	+5000
6,80 €	6,50 €	6,28 €	5,98 €

parasol para
camión

new **columbia**



130 X 80 CM

BATUR_ 0102

Parasol tamaño maxi con burbuja a doble cara realizado en aluminio acabado metalizado y ribete en poliéster. Argollas metálicas con ventosas y cintas elásticas para plegado incluidas. Presentación en plano.

130 x 80 cm

100

G(1)

-500	+500	+2000	+5000
4,18 €	4,08 €	3,98 €	3,88 €

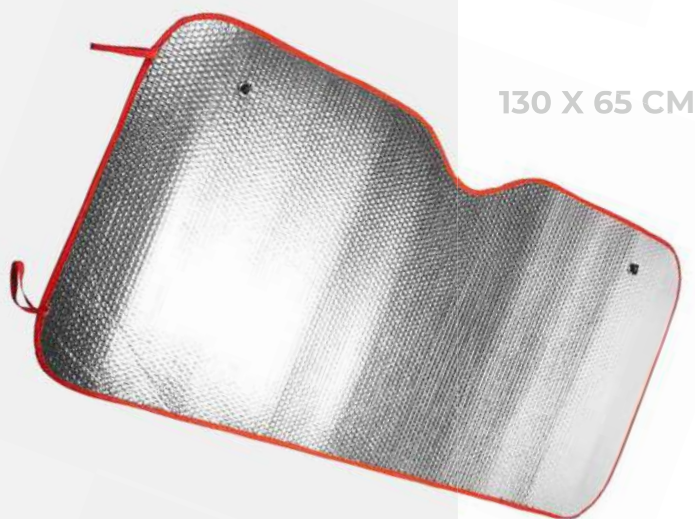

130 X 65 CM

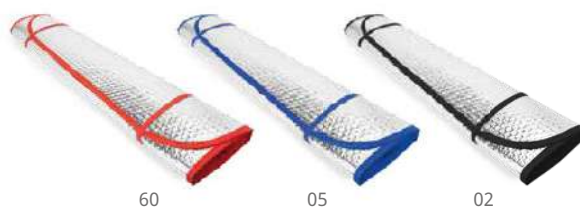

60

05

02

KINI_ 0101

Parasol con burbuja a doble cara realizado en aluminio acabado metalizado y ribetes en color. Argollas metálicas con ventosas y cintas elásticas para plegado incluidas. Presentación en plano.

130 x 65 cm

100

G(1)

-500	+500	+2000	+5000
3,32 €	3,22 €	3,12 €	3,02 €

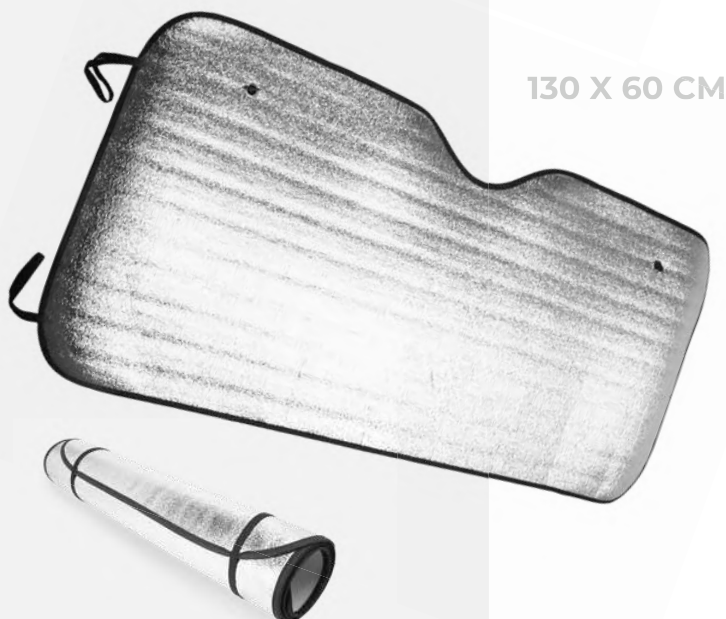

130 X 60 CM

AKALA_ 0100

Parasol con frontal en aluminio de acabado metalizado, ribete de poliéster y argollas metálicas reforzadas. Ventosas de sujeción y gomas elásticas para plegado incluidas. Presentación en plano.

130 x 60 cm

100

G(1)

-500	+500	+2000	+5000
2,50 €	2,40 €	2,30 €	2,20 €

new.



60



05



02

KORAT_ 1021

Collar para mascotas en resistente y suave poliéster. Cinta ajustable y hebilla con cierre de clic. Incluye anilla metálica para correa de paseo.

51 x 2,5 cm 20 300

F(1)

-500	+500	+2000	+5000
1,02 €	0,98 €	0,94 €	0,90 €



for your
puppy



new.



01 03 31 60 05 226 02

SIMBA_ 1018

Dispensador de bolsas para mascotas con mosquetón de transporte a juego. Incluye 15 bolsas.

8,2 x 4,1 x 5,4 cm 50 200

D(4)

-500	+500	+2000	+5000
0,640 €	0,620 €	0,580 €	0,560 €





Create your set



new.



03

60

05

LANZA_ 1020

Pelota para mascotas en resistente goma y tejido reforzado.

Ø6,4 cm

20

200

N(8), L1

-500	+500	+2000	+5000
0,900 €	0,860 €	0,820 €	0,780 €



new.



60

05

226

SHIRA_ 1019

Bowl plegable para mascotas. Apto para líquidos y sólidos. Capacidad 450 ml. Incluye mosquetón metálico para transporte a juego.

5,2 x Ø12,9 cm

50

200

L2

-500	+500	+2000	+5000
1,30 €	1,26 €	1,22 €	1,16 €



SUBLIMATION



01

SISON_ 7154

Mochila ligera y compacta, en resistente poliéster 600D. Bolsillo frontal con apertura vertical y acolchado en espalda y tirantes. Etiqueta removible.

34 x 40 x 12 cm  1  50

 F(1), N(8), O, R

-500	+500	+2000	+5000
3,20 €	3,04 €	2,92 €	2,82 €



01



NINFA_ 7152

Mochila de cordones con esquinas reforzadas realizada en poliéster 210D. Bolsillo frontal con cremallera y salida para cables. Etiqueta removible.

34,5 x 45 cm  10  200

 F(1), N(8), R

-500	+500	+2000	+5000
1,18 €	1,14 €	1,10 €	1,04 €



01



HAMELIN_ 7114

Mochila de cordones con ojales metálicos, realizada en poliéster 210D. Etiqueta removible.

34 x 42 cm  50  300

 F(1), N(8), R

-500	+500	+2000	+5000
0,840 €	0,820 €	0,790 €	0,750 €



TRENTO_ 7127

Bolsa sublimable de non-woven 80 g/m² con resistentes asas troqueladas y acabado termosellado. Ideal para sublimación.

34 x 43 cm 20 400

F(1), N(8), R

-500	+500	+2000	+5000
0,400 €	0,380 €	0,360 €	0,340 €



MITO_ 7527

Bolsa de la compra en non-woven cosido con asas reforzadas. Ideal para sublimación. Asas de 70 cm.

36 x 40 cm 50 250

F(1), N(8), R

-500	+500	+2000	+5000
0,560 €	0,540 €	0,520 €	0,500 €

BAGS



01

CLOUD_ 8110

Funda para gafas con cordones autocierre. Poliéster de tacto suave.

9 x 18 cm 50 1000

D(1), N(8), R

-500	+500	+2000	+5000
0,400 €	0,380 €	0,370 €	0,350 €



01

TOCO_ 7522

Bolsa de la compra plegable de suave poliéster 190T en acabado cosido. Incluye práctica banda elástica para su plegado.

42,5 x 38 x 7 cm 20 400

E(1), G(1), H(1), R

-500	+500	+2000	+5000
0,800 €	0,780 €	0,750 €	0,730 €



400ml

ATHLETIC_ 4045

Bidón de aluminio con mosquetón. Capacidad 400 ml. Presentación en caja diseño.

17,5 x Ø6,6 cm 1 50
F(1), L2, Q

-500	+500	+2000	+5000
2,72 €	2,62 €	2,56 €	2,46 €

800ml

BAOBAB_ 4049

Bidón de aluminio con mosquetón. Capacidad 800 ml. Presentación en caja diseño.

24,6 x Ø7,3 cm 1 50
F(1), L2

-500	+500	+2000	+5000
5,92 €	5,72 €	5,46 €	5,22 €

500ml
DOUBLE WALL

SALVIA_ 4123

Termo de acero inoxidable 304 con doble pared. Acabado brillo. Capacidad 500 ml. Presentación en caja diseño.

24,5 x Ø6,9 cm 1 30
F(1), L2, Q

-500	+500	+2000	+5000
7,76 €	7,56 €	7,26 €	7,02 €

500ml

CAMU_ 4040

Bidón de cristal de 500 ml. Funda y cinta de transporte a color. Presentación en caja diseño.

22 x Ø6,7 cm 1 40
F(1), N(8), L2, Q

-500	+500	+2000	+5000
2,18 €	2,14 €	2,08 €	1,96 €

650ml

BOINA_ 4039

Bidón de acero inoxidable 304 y bambú. Capacidad 650 ml. Presentación en caja diseño.

20,5 x Ø7,3 cm 1 50
F(1), L2, Q

-500	+500	+2000	+5000
5,92 €	5,72 €	5,46 €	5,22 €



KASTER_ 4098

Bidón de cristal de 600 ml. Incluye funda a color con asa para transporte. Presentación en caja diseño.

16,2 x Ø8,8 cm 1 40

F(1), N(8), L2, R

-500	+500	+2000	+5000
2,94 €	2,80 €	2,70 €	2,60 €



SUBLIMATION



DOUBLE WALL

COPO_ 4059

Bidón termo de acero inoxidable 304 con doble pared especial para sublimación. Capacidad 500 ml. Presentación en caja diseño.

25,5 x Ø7,3 cm 1 30

F(1), L2, Q

-500	+500	+2000	+5000
9,18 €	8,88 €	8,58 €	8,32 €



ACABADO MATE

350ml

RAMBU_ 4003

Taza de cerámica de 350 ml con diseño en acabado mate. Especial para sublimación. Presentación en caja blanca.

9,6 x Ø8,2 cm 1 36



-500	+500	+2000	+5000
2,70 €	2,60 €	2,50 €	2,40 €



ACABADO BRILLO

350ml

LIMA_ 4000

Taza de cerámica de 350 ml especial para sublimación. Presentación en caja blanca.

9,6 x Ø8,2 cm 1 36



-500	+500	+2000	+5000
2,18 €	2,14 €	2,04 €	1,96 €



TAZA CRISTAL

340ml

KAFFIR_ 4060

Taza de cristal de 340 ml. Especial para sublimación. Presentación en caja eco.

9,5 x Ø8 cm 1 36

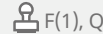

-500	+500	+2000	+5000
2,64 €	2,54 €	2,42 €	2,36 €



ACABADO BRILLO

250ml

MARANG_ 4084

Taza de cerámica de 250 ml, especial para sublimación. Presentación en caja blanca.

8,4 x Ø7,4 cm 1 48



-500	+500	+2000	+5000
2,04 €	1,94 €	1,88 €	1,82 €

new.



0102

0160

0105



KUMBO_4002

Taza de cerámica con diseño retro especial para sublimación. Capacidad 300 ml. Presentación en caja blanca.

8,7 x Ø8,3 cm 1 36



-500	+500	+2000	+5000
3,36 €	3,20 €	3,06 €	2,88 €

SUBLIMATION



0103

0131

0160

0105

01226

0102



MANGO_4001

Taza de cerámica de 350 ml especial para sublimación. Interior y asa en color. Presentación en caja blanca.

9,6 x Ø8,2 cm 1 36



-500	+500	+2000	+5000
2,68 €	2,64 €	2,54 €	2,48 €



TAZA METÁLICA

.....



DAMASCO_4014

Taza metálica de estilo retro especial para sublimación. Capacidad 380 ml. Presentación en caja blanca.

7,9 x Ø8,8 cm 1 48



-500	+500	+2000	+5000
3,80 €	3,70 €	3,50 €	3,40 €

magic mugs



OKRA_4085

Taza mágica de cerámica en acabado mate. 350 ml de capacidad. Vierte líquido caliente en ella y descubre el diseño escondido. Presentación en caja blanca.

9,6 x Ø8,2 cm 1 36

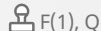

-500	+500	+2000	+5000
3,70 €	3,60 €	3,44 €	3,30 €



Ø105

FARGO_ 5611

Paraguas con mango en madera y apertura automática. Varillas y terminaciones en negro. Cierre con velcro. Fabricado en poliéster 190T.

85 x Ø105 cm 1 40
G(1), N(8), R

-500	+500	+2000	+5000
4,74 €	4,60 €	4,40 €	4,24 €

Ø95

YAKU_ 5606

Paraguas plegable de apertura manual con funda a juego. Mango, varillas y contera plateados. Cierre con velcro. Fabricado en poliéster 190T.

24 x Ø5 cm 1 60
G(1), N(8), R

-500	+500	+2000	+5000
3,30 €	3,20 €	3,10 €	3,00 €



Ø105

MILFORD_ 5608

Paraguas con tela y mango a juego. Varillas y terminaciones en negro. Cierre con velcro y apertura automática. Fabricado en poliéster 190T.

83 x Ø105 cm 1 25
G(1), N(8), R

-500	+500	+2000	+5000
4,50 €	4,30 €	4,10 €	3,90 €



Ø130

WIND-PROOF

HARUL_ 5609

Paraguas XL de poliéster 190T con mango, bastón y terminaciones en negro. Varillas largas de fibra de vidrio con sistema anti-viento. Botón de apertura automática. Mango de EVA. Cierre con velcro a juego.

98 x Ø130 cm 1 25
G(1), N(8), R

-500	+500	+2000	+5000
5,60 €	5,50 €	5,30 €	5,14 €



Lanyards & pulseras

100% made to order

- Impresión en sublimación incluida
- Pedido mínimo 250pcs



ARETA_3097

Pulsera ajustable de poliéster especial para sublimación con cierre retornable.

30 x 1,5 cm 10000 Q

-500	+500	+2000	+5000
0,530 €	0,510 €	0,500 €	0,490 €



SPRING_3095

Pulsera ajustable de poliéster especial para sublimación con cierre no retornable.

30 x 1,5 cm 10000 Q

-500	+500	+2000	+5000
0,550 €	0,530 €	0,520 €	0,510 €



SILVANO_3012

Alfombrilla para ratón realizada en poliéster suave con reposamuñecas acolchado. Base antideslizante de silicona.

20,5 x 24,3 x 2 cm 1 100

E(1), N(8), R

-500	+500	+2000	+5000
2,64 €	2,52 €	2,40 €	2,24 €



PARADIS_3096

Pulsera ajustable de poliéster especial para sublimación sin cierre.

30 x 1,5 cm 10000 Q

-500	+500	+2000	+5000
0,380 €	0,364 €	0,352 €	0,330 €



KENDAL_4124

Llavero con tiras de poliéster especial para sublimación.

12 x 2 cm 2000 Q

-500	+500	+2000	+5000
0,900 €	0,860 €	0,820 €	0,780 €



SINATRA_7071

Lanyard de poliéster doble con mosquetón especial para sublimación.

50 x 2 cm 100 500 Q

-500	+500	+2000	+5000
1,38 €	1,34 €	1,30 €	1,26 €



ELVIS_7049

Lanyard de poliéster con mosquetón especial para sublimación.

50 x 2 cm 100 500 Q

-500	+500	+2000	+5000
1,10 €	1,06 €	1,02 €	0,98 €



SIRA_3011

Alfombrilla para ratón de diseño plano. Superficie de poliéster suave y base antideslizante de silicona.

22 x 18 x 0,2 cm 100 200

E(1), R

-500	+500	+2000	+5000
0,480 €	0,460 €	0,440 €	0,420 €

new.



60 05

226 02

ROGER_9134

Manopla de cocina en poliéster. Acabado en color blanco con bordes y cinta para colgar en color. Cara lisa ideal para sublimación.

19 x 30,5 cm 50 200

E(1), N(8), R

-500	+500	+2000	+5000
2,04 €	1,96 €	1,86 €	1,78 €



**PARTY &
EVENTS**



sombreros naturales



29



02

LEVY_ 7014

Sombrero de fibra sintética de gran calidad con banda confort interior.



Consultar



25



100

-500
1,98 €

+500
1,92 €

+2000
1,83 €

+5000
1,74 €



02

07

new.

JONES_7018

Sombrero de ala plana en material sintético con banda confort interior.

Consultar 25 100

-500	+500	+2000	+5000
2,46 €	2,42 €	2,32 €	2,24 €



new.



02



07



29

BELOC_7015

Sombrero en material sintético con banda confort interior.

Consultar 25 100



-500	+500	+2000	+5000
2,12 €	2,06 €	2,02 €	1,94 €

natural hats



HALLEY_ 7062

Sombrero de paja natural con banda confort interior.

 Consultar  250

-500	+500	+2000	+5000
1,30 €	1,26 €	1,22 €	1,18 €



SUN_ 7061

Sombrero de paja natural con banda confort interior.

 Consultar  250

-500	+500	+2000	+5000
1,30 €	1,26 €	1,22 €	1,18 €

**GALAXY_7063**

Sombrero de paja natural con banda confort interior.

Consultar 250

-500	+500	+2000	+5000
1,14 €	1,10 €	1,06 €	1,04 €

COMET7063

cintas de marcaje

Cintas de Non Woven para darle un toque de color a tus sombreros

COMET_7013

Cinta para sombrero de non-woven.

67 x 2,7 cm 500 5000

Consultar

-500	+500	+2000	+5000
0,045 €	0,044 €	0,042 €	0,040 €



01 03 31 60 55 05 242 13 56 226 02



DUSK_ 7060

Sombrero de poliéster.

E(1) 25 200

-500	+500	+2000	+5000
1,03 €	1,01 €	0,97 €	0,95 €



CARNIVAL_ 3101

Silbato de diseño clásico con cinta para el cuello.

1,9 x 2,4 x 5 cm 250 1000

C(1)

-500	+500	+2000	+5000
0,158 €	0,150 €	0,146 €	0,140 €

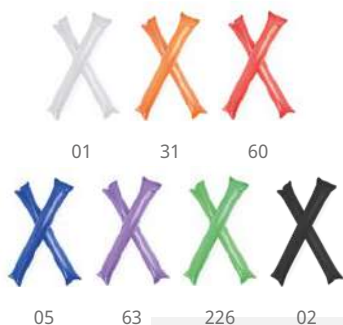

JAMBOREE_ 3106

Set de bastons / aplaudidores inflables y reutilizables realizados en LDPE. Incluye válvula de inflado.

61 x Ø10 cm 25 500

G(1)

-500	+500	+2000	+5000
0,160 €	0,156 €	0,150 €	0,146 €



REVEL_ 3105

Aplaudidor con diseño bicolor en forma de mano.

18,5 x 8,5 cm 100 200

E(4)

-500	+500	+2000	+5000
0,320 €	0,310 €	0,300 €	0,290 €



157

158

161

FLAG_ 4080

Llavero de poliéster con diseño de bandera y refuerzo de PU.

12 x 3 cm 50 400

E(1), L1

-500	+500	+2000	+5000
0,380 €	0,360 €	0,340 €	0,330 €



SUBLIMACIÓN



01

03

31

60

05

226

63

158

157

161

162



CELEB_ 3103

Banderín de animación realizado en poliéster 170T. Disponible en colores lisos y banderas.

21 x 14 cm 10 2000

D(6)

-500	+500	+2000	+5000
0,112 €	0,106 €	0,100 €	0,094 €



ALBERO_ 3110

Abanico con varillas de plástico y tela en poliéster.
Presentación en caja blanca.

43 x 23 cm 25 250
D(1), E(2)

-500	+500	+2000	+5000
0,750 €	0,730 €	0,700 €	0,680 €



CALESA_ 3111

Abanico con varillas de madera y tela en poliéster.
Presentación en caja blanca.

42,5 x 23 cm 25 250
D(1), E(2), L1

-500	+500	+2000	+5000
1,56 €	1,48 €	1,40 €	1,32 €



FESTERO_ 9003

Pañoleta de diseño triangular en suave poliéster de 60 g/m². Color blanco ideal para marcaje en sublimación. Talla única.

100 x 70 x 70 cm 100 1000
E(1), N(8), R

-500	+500	+2000	+5000
0,430 €	0,420 €	0,410 €	0,390 €

algodón & bambú



new.

ORBIT_ 3098

Pulsera de algodón natural con cierre de seguridad (no retornable) en bambú.

35 x 1,5 cm 100 2000

D(1)

-500	+500	+2000	+5000
0,620 €	0,590 €	0,570 €	0,550 €



CIERRE DE SEGURIDAD

para todos los **eventos**



SUBLIMACIÓN



01 03 31 60 05 226 02 40

FETE_ 3102

Pulsera ajustable de poliéster.

34,5 x 1,2 cm 500 2000

D(1), R

-500	+500	+2000	+5000
0,099 €	0,097 €	0,094 €	0,090 €



01 03 221 31 60 05 242 226 02 258 40

PARTY_ 3100

Pulsera para eventos de fibra sintética con numeración individual. Presentación en plancha de 10 unidades.

25,8 x 2,7 cm 1000 20000

A(1)

-500	+500	+2000	+5000
0,052 €	0,048 €	0,044 €	0,040 €



GUEST_ 7054

Lanyard de poliéster con mosquetón, hebilla y cierre de seguridad.

2 x 55 cm 100 600

F(1), N(8), R

-500	+500	+2000	+5000
0,340 €	0,320 €	0,310 €	0,300 €

lanyards

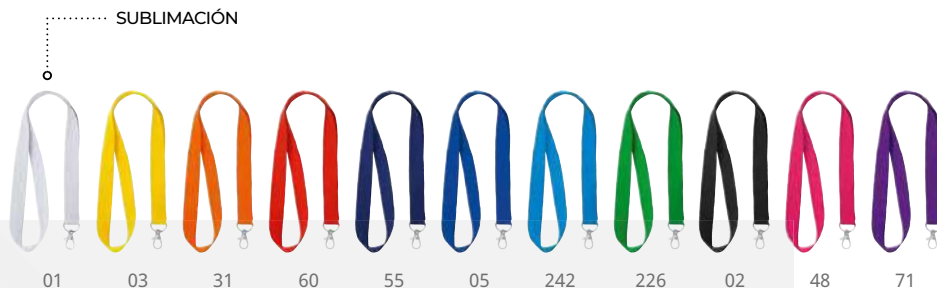

HOST_ 7053

Lanyard de poliéster con mosquetón.

2 x 50 cm 100 800

F(1), N(8), R

-500	+500	+2000	+5000
0,220 €	0,210 €	0,190 €	0,180 €

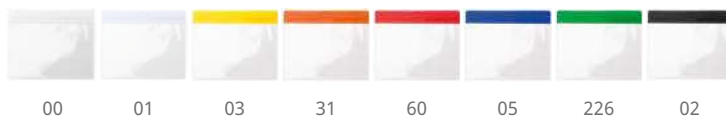

BASH_ 7070

Identificador transparente de PVC.

11 x 9,5 x 0,05 cm 100 1000

C(1)

-500	+500	+2000	+5000
0,150 €	0,140 €	0,110 €	0,100 €



100% ALGODÓN

ROOMER_ 7052

Lanyard de algodón con mosquetón.

2 x 50 cm 100 800

F(1), N(8)

-500	+500	+2000	+5000
0,480 €	0,470 €	0,450 €	0,410 €

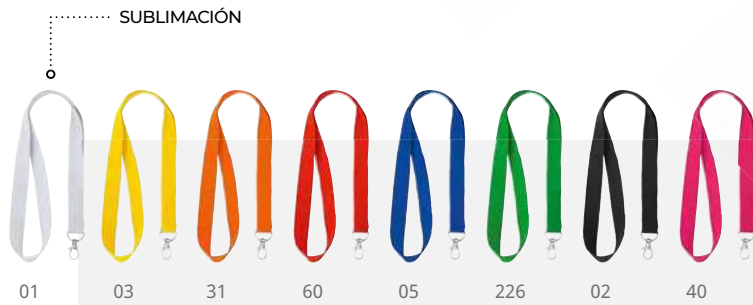

ECOHOST_ 7055

Lanyard de RPET con mosquetón.

2 x 50 cm 100 800

F(1), N(8), R

-500	+500	+2000	+5000
0,360 €	0,350 €	0,340 €	0,330 €

RPET
lanyard



artículos personalizados

bajo pedido



- Impresión en sublimación incluida
- Pedido mínimo 250pcs



ARETA_ 3097

Pulsera ajustable de poliéster especial para sublimación con cierre retornable.

30 x 1,5 cm R

-500	+500	+2000	+5000
0,530 €	0,510 €	0,500 €	0,490 €



CIERRE DE SEGURIDAD

SPRING_ 3095

Pulsera ajustable de poliéster especial para sublimación con cierre no retornable.

30 x 1,5 cm R

-500	+500	+2000	+5000
0,550 €	0,530 €	0,520 €	0,510 €



PARADIS_ 3096

Pulsera ajustable de poliéster especial para sublimación sin cierre.

30 x 1,5 cm R

-500	+500	+2000	+5000
0,380 €	0,364 €	0,352 €	0,330 €

100% personalizable



KENDAL_ 4124

Llavero mosquetón con tiras de poliéster especial para sublimación.

12 x 2 cm  R

-500	+500	+2000	+5000
0,900 €	0,860 €	0,820 €	0,780 €



SINATRA_ 7071

Lanyard de poliéster doble con mosquetón especial para sublimación.

50 x 2 cm  R

-500	+500	+2000	+5000
1,38 €	1,34 €	1,30 €	1,26 €



ELVIS_ 7049

Lanyard de poliéster con mosquetón especial para sublimación.

50 x 2 cm  R

-500	+500	+2000	+5000
1,10 €	1,06 €	1,02 €	0,98 €



SUMMER



toalla pareo

new.



05

55

58

60

DENIA_7096

Toalla/Pareo 90% algodón / 10% poliéster. 180 g/m².

180 x 90 cm

1

50

G(1), N(8), O, P

-500	+500	+2000	+5000
7,70 €	7,40 €	7,10 €	6,80 €

ORLY



01

60

55

05

226

46

ORLY_7100

Toalla de playa en diseño bicolor con práctico elástico para su fácil plegado. 80% poliéster y 20% poliamida de 280 g/m².

S 38 x 68 cm

10

100

M 60 x 145 cm

10

50

Consultar

	Caja	Pack	Unidad
S	2,400 €	2,520 €	-
M	6,200 €	6,510 €	-



2 TAMAÑOS



01

96

60

05

55

02

BOBIN_ 6999

Gorro estilo bob 100% algodón

32 x Ø60 cm 50 200

E(1), N(8), O, P

-500	+500	+2000	+5000
1,08 €	1,04 €	1,02 €	0,98 €



new.

226



01

03

31

60

05

226

02

40



KALAY_ 8150

Chanclas de playa con suela de confortable PE y tiras en PVC translúcido. Tallas 36-38, 42-44.

26 x 1,3 x 9,5 cm 10 60

D(1), E(1)

-500	+500	+2000	+5000
1,46 €	1,42 €	1,36 €	1,30 €

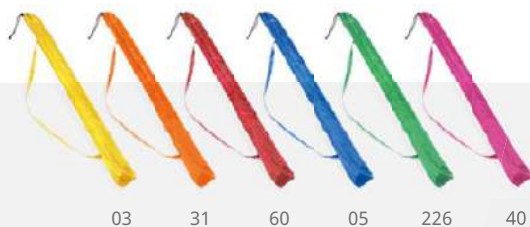

03

31

60

05

226

40

SKYE_ 1006

Sombrilla de playa de 8 paneles realizada en nylon. Protección UV interior y faldones ribeteados. Incluye funda de transporte con cinta para el hombro.

100 x Ø155 cm 1 12

H(1), N(8)

-500	+500	+2000	+5000
8,90 €	8,66 €	8,46 €	8,20 €



PROTECCIÓN UV



CALON_ 1022

Fribee de diseño clásico en resistente PP.

1,8 x Ø23 cm 100 200

D(1)

-500	+500	+2000	+5000
0,920 €	0,880 €	0,860 €	0,820 €

new



calon

fun days

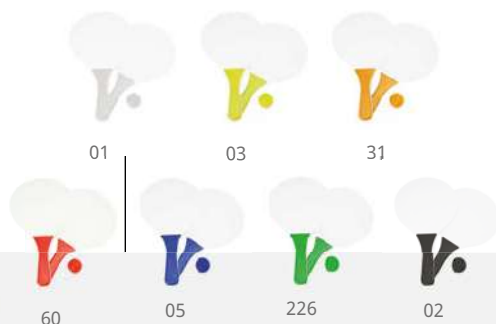

FEROE_ 1003

Palas de playa realizadas en madera con mango reforzado a color. Incluye pelota a juego. Presentadas en bolsa tipo red.

18,5 x 33 x 0,6 cm

1

30

F(1)

-500	+500	+2000	+5000
2,56 €	2,40 €	2,26 €	2,10 €



SAONA_ 2150

Balón inflable de PVC. Desinflado: 37 cm. Inflado: 28 cm.

Ø28 cm

100

200

E(1), F(1)

-500	+500	+2000	+5000
0,730 €	0,700 €	0,680 €	0,654 €



saona

TÁCTIL

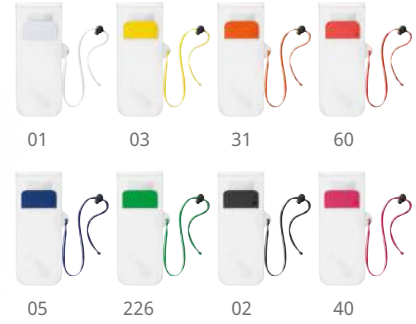

EIDER_8202

Portatodo impermeable de PVC apto para pantallas táctiles.

9,5 x 23 cm 50 500
E(1)

-500	+500	+2000	+5000
0,480 €	0,460 €	0,440 €	0,420 €



CENIX_1023

Cenicero de bolsillo con interior en aluminio ignífugo. Cierre de solapa con botón.

8 x 1,1 x 8 cm 50 500
C(1)

-500	+500	+2000	+5000
0,458 €	0,448 €	0,432 €	0,420 €

new.



new.



TÁCTIL



LANKA_8205

Portatodo impermeable grande de PVC apto para pantallas táctiles.

21 x 13 cm 50 300
E(1)

-500	+500	+2000	+5000
0,780 €	0,740 €	0,720 €	0,700 €

bolsa estanca



2,5L

ALETA_7531

Bolsa impermeable de resistente ripstop, con práctica ventana con bolsillo para el móvil. Sistema de cierre estanco con clic y mosquetón de transporte. 2,5 L de capacidad útil. 3 L de capacidad total.

29,5 x Ø11,5 cm 10 200

G(1)

-500	+500	+2000	+5000
2,98 €	2,88 €	2,72 €	2,60 €



5L

MONJE_7532

Bolsa impermeable de resistente ripstop. Sistema de cierre estanco con clic y mosquetón de transporte. 5 L de capacidad útil. 8,5 L de capacidad total.

35 x Ø18 cm 10 100

G(1)

-500	+500	+2000	+5000
4,36 €	4,16 €	3,96 €	3,76 €



10L

MANATI_7533

Bolsa impermeable de resistente ripstop. Sistema de cierre estanco con clic. Mosquetón y cinta bandolera ajustable para transporte. 10 L de capacidad útil. 15 L de capacidad total.

45,5 x Ø20,5 cm 10 100

G(1)

-500	+500	+2000	+5000
6,50 €	6,30 €	6,10 €	5,90 €

refresca todos tus momentos

new.



KINTO_ 4121

Cubo metálico con asa. Incluye abridor de aluminio.
Capacidad 6L.

18,5 x Ø23 cm  1  20

 G(1)

-500	+500	+2000	+5000
6,42 €	6,14 €	5,90 €	5,60 €



natural coolerbag



new.



INTERIOR ISOTÉRMICO

CIERRE VELCRO

VENICE_ 7161

Bolsa nevera de yute laminado. Interior isotérmico de aluminio con cierre de velcro. Bolsillo frontal y asas en algodón natural.

43 x 20 x 34 cm 10 40
F(1)

-500	+500	+2000	+5000
7,90 €	7,70 €	7,46 €	7,20 €



KEMER_ 7600

Bolsa nevera de papel laminado con interior isotérmico de aluminio. Solapa y bolsillo exterior con cierre de velcro.

19 x 32 x 12 cm 25 100
F(1)

-500	+500	+2000	+5000
2,12 €	2,03 €	1,94 €	1,85 €



new.



MILANA_7607

Nevera de papel laminado de diseño clásico, interior isotérmico de aluminio y solapa con cierre de cremallera. Práctica asa de transporte incluida.

19 x 13,5 x 14 cm 25 100

F(1)

-500	+500	+2000	+5000
2,54 €	2,42 €	2,32 €	2,20 €



03

60



05

226

SERRETA_7606

Bolsa nevera de papel laminado, con interior isotérmico de aluminio. Solapa con cierre de velcro y práctica asa de transporte a color.

20 x 25 x 10 cm 50 100

F(1)

-500	+500	+2000	+5000
2,04 €	1,98 €	1,90 €	1,78 €



05 226 02 40 01 03 31 60

GRAJA_7604

Mochila nevera de cordones con interior isotérmico de aluminio. Exterior de poliéster 210D.

32 x 42 cm 10 200

G(1), N(8)

-500	+500	+2000	+5000
1,05 €	1,01 €	0,98 €	0,86 €



01 31 60 05 226

TIBU_7603

Nevera con interior isotérmico de aluminio para 6 latas. Exterior en resistente PVC. Asa de transporte a juego y cierre de cremallera.

21 x 15 x 15 cm 25 200

F(1), N(8)

-500	+500	+2000	+5000
1,43 €	1,39 €	1,35 €	1,30 €

gafas de sol



EDEN



02



01



BAMBOO

EDEN_ 8104

Gafas de sol de atractivo diseño con montura en acabado brillante y patillas en bambú natural. Lentes con protección UV400.

 14,5 x 5 cm  10  300

 D(4), L1

-500	+500	+2000	+5000
4,90 €	4,68 €	4,46 €	4,30 €

DAX



DAX_8102

Gafas de sol de diseño clásico en acabado efecto madera con protección UV400.

14,5 x 4,9 x 3,2 cm

10

300

E(1)

-500	+500	+2000	+5000
1,06 €	1,03 €	0,99 €	0,96 €



SUBLIMACIÓN



CLOUD_8110

Funda para gafas con cordones autocierre. Poliéster de tacto suave.

9 x 18 cm

50

1000

D(1), N(8), R

-500	+500	+2000	+5000
0,400 €	0,380 €	0,370 €	0,350 €

CLOUD



31



03



251



05

CIRO_8101

Gafas de sol de diseño clásico en acabado negro mate y lentes de espejo. Protección UV400.

14,5 x 4,9 x 3,2 cm

10

300

D(4)

-500	+500	+2000	+5000
1,36 €	1,30 €	1,24 €	1,18 €

**BRISA_ 8100**

Gafas de sol de diseño clásico en acabado brillo con protección UV400.

14,5 x 4,9 x 3,2 cm 10 300

D(4)

-500	+500	+2000	+5000
0,740 €	0,710 €	0,690 €	0,640 €

**ARIEL_ 8103**

Gafas de sol con montura en acabado mate y lentes con protección UV400.

14,5 x 5 cm 10 300

D(4)

-500	+500	+2000	+5000
0,540 €	0,510 €	0,490 €	0,460 €



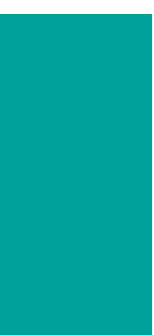

LEISURE
& **SPORTS**



bastones trekking



60

05

02

new.

VULCAN_ 7095

Set de bastones plegables en aluminio con sistema de amortiguación. Agarre ergonómico y cinta de seguridad ajustable. Incluye accesorio para nieve. Superficie de contacto con el suelo reforzada. Presentación en práctica bolsa de transporte con cinta para hombro.

140 x Ø cm

1

20

G(1), L2, N(8)

-500	+500	+2000	+5000
15,90 €	15,20 €	14,40 €	13,60 €

3 accesorios



crossfitter

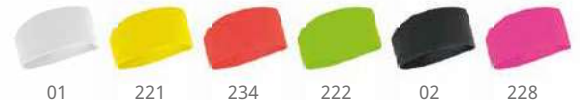

CROSSFITTER_ 9001

Cinta deportiva en tejido técnico transpirable. 100% poliéster de 140 g/m².

22,5 x 8 cm 10 300

Consultar

Caja	Pack	Unidad
1,200 €	1,260 €	-



OLYMPIA_ 7104

Cinta elástica deportiva para la cabeza realizada en suave microfibra.

23,5 x 6 cm 100 800

G(1), N(8), R

-500	+500	+2000	+5000
0,934 €	0,894 €	0,844 €	0,814 €

BOLSILLO



SPEED_ 7105

Muñequera elástica realizada en suave microfibra. Bolsillo con cierre de cremallera incorporado.

10 x 9 cm 100 1000

E(1), N(8), R

-500	+500	+2000	+5000
0,960 €	0,920 €	0,900 €	0,860 €



MARATHON_ 7118

Cinturón deportivo multiusos de tejido elástico impermeable. Cremallera reflectante y salida para cables. 100% poliéster. Etiqueta removible.

23 x 5,5 cm 10 200

Consultar

Caja	Pack	Unidad
2,900 €	3,046 €	-

new.

**REGINA_ 7093**

Cuerda de saltar en algodón con mangos de madera lisos. Presentación en bolsa de algodón.

280 x Ø2,7 cm 1 50

D(1), L1

-500	+500	+2000	+5000
5,54 €	5,34 €	5,10 €	4,90 €

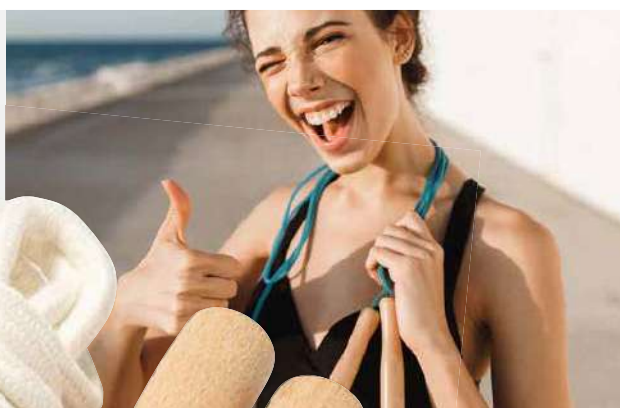

fitness products

new.

ROCKY_ 7094

Cuerda de saltar técnica regulable. Incluye funda para guardar con cordones.

300 x 14,5 cm 1 100



D(1)

-500	+500	+2000	+5000
4,50 €	4,30 €	4,16 €	4,00 €



bandas elásticas

3 levels

	SOFT
	MEDIUM
	HARD



EMON_ 7097

Set de bandas elásticas para fitness con diferentes niveles de resistencia. Funda de poliéster.

 9 x 21 cm  20  100

 E(1), N(8)

-500	+500	+2000	+5000
3,30 €	3,16 €	3,00 €	2,86 €

esterilla para yoga





60

05

02

CHAKRA_ 7102

Esterilla de yoga con práctica funda de transporte. Ligera, resistente y adherente al suelo.

 180 x 60 cm  1  20

 G(1), K(1)

-500	+500	+2000	+5000
11,70 €	11,30 €	10,84 €	10,38 €



BOLSA
TRANSPORTE



01 28 05 46 02 78

CORK_7119

Toalla multi-deporte de microfibra con práctica banda elástica para su fácil plegado. Secado rápido. 90% poliéster y 10% poliamida de 190 g/m². Etiqueta removible.

70 x 120 cm 10 100

Consultar

Caja	Pack	Unidad
5,900 €	6,195 €	-

FUNDA TRANSPORTE



BAY_7103

Toalla absorbente realizada en microfibra de 345 g/m². Funda reutilizable de PVC incluida.

45 x 30 cm 1 100

F(1), N(8), O, P, R

-500	+500	+2000	+5000
1,03 €	0,99 €	0,96 €	0,93 €

+ antibacterial

ISO 22196

*Material tratado con Iones de Plata que evita la ploriferación de las bacterias.



SANCAR_9938

Toalla absorbente de suave microfibra con tratamiento anti-bacterias. Presentación en funda de PVC.

45 x 30 cm 1 100

G(1), N(8)

-500	+500	+2000	+5000
1,64 €	1,58 €	1,52 €	1,44 €



CALPE_7101

Toalla refrescante de microfibra. Presentación en práctico estuche con mosquetón.

13 x 5,4 x 3 cm 50 200

G(1), N(8)

-500	+500	+2000	+5000
1,78 €	1,71 €	1,64 €	1,58 €

gorra y visera especial deporte



01 05 221 234 02

MERCURY_7020

Gorra técnica de 3 paneles. Tejido ligero y transpirable con cierre de velcro ajustable. 90% poliéster y 10% elastano de 140 g/m². Etiqueta removible.

Consultar 25 200

Caja	Pack	Unidad
2,920 €	3,066 €	-

new.



01 31 60 05 02

WIZER_7048

Visera deportiva de poliéster. Con cierre de velcro y laterales acolchados.

E(1), N(8), O, P, R 25 250

-500	+500	+2000	+5000
2,20 €	2,10 €	2,02 €	1,92 €

new.



FUNDA
TRANSPORTE



01 03 31 60 05 226 40

KELSEY_7057

Toalla absorbente realizada en microfibra 185 g/m². Incluye funda de transporte con cierre ajustable.

100 x 50 cm 1 100

G(1), N(8), O, P, R

-500	+500	+2000	+5000
3,26 €	3,12 €	3,02 €	2,90 €

100% Recycled PET



CALISTO_7050

Gorra de RPET con 5 paneles. Cierre de velcro ajustable.

Ø60 cm 75 300

E(1), N(8), O, P

-500	+500	+2000	+5000
1,98 €	1,93 €	1,85 €	1,78 €

RROLY



BASICA_7000

Gorra de 5 paneles en 80% poliéster y 20% algodón, con orificios de ventilación bordados y cierre de velcro ajustable. Etiqueta removable.

Consultar 25 300

Caja	Pack	Unidad
1,080 €	1,134 €	

RROLY



URANUS_7041

Gorra de 5 paneles en 100% algodón de 170 g/m². Cierre ajustable de velcro y orificios de ventilación bordados. Etiqueta removable.

Consultar 25 300

Caja	Pack	Unidad
1,58 €	1,66 €	-

RROLY

**ERIS_7019**

Gorra de 5 paneles con sándwich a contraste y cuatro orificios de ventilación bordados. Cierre de velcro ajustable y etiqueta removible. 100% algodón de 170 g/m².

Consultar 25 200

Caja	Pack	Unidad
1,800 €	1,890 €	-

**PANEL_7008**

Gorra de 6 paneles en 100% algodón con sándwich a contraste. 6 orificios de ventilación y cierre de velcro ajustable. Etiqueta removible.

Consultar 25 200

Caja	Pack	Unidad
2,000 €	2,100 €	-



RROLY

**TERRA_7012**

Gorra de estilo casual de 6 paneles. Interior de la visera en acabado contraste. Ojales y cierre ajustable metálicos. 100% algodón de 260 g/m². Etiqueta removible.

Consultar 25 200

Caja	Pack	Unidad
3,100 €	3,256 €	-

RROLY





PERSONAL CARE



natural jute bags





new.



VERA_ 7563

Neceser realizado en algodón y yute laminado.
Cremallera con tirador de yute a juego.

20 x 15 x 6 cm  50  200

 E(1), N(8)

-500	+500	+2000	+5000
2,08 €	2,02 €	1,90 €	1,82 €

new.



SIENA_ 7564

Neceser realizado en algodón y yute laminado.
Cremallera con tirador de yute a juego.

21 x 6 x 11 cm  50  200

 E(1), N(8)

-500	+500	+2000	+5000
2,30 €	2,20 €	2,10 €	1,98 €



COFFINO & JUTE



SIERRA_7558

Neceser multiusos realizado en algodón de 180 g/m² y yute. Cremallera con tirador de yute a juego.

21,5 x 16 x 5 cm 10 200

E(1), N(8)

-500	+500	+2000	+5000
1,50 €	1,44 €	1,39 €	1,35 €



DOEL_7537

Neceser multiusos en algodón de 280 g/m² con acabado bicolor. Cremallera con tirador de algodón a juego.

22,5 x 17 x 5,5 cm 50 300

E(1), N(8)

-500	+500	+2000	+5000
1,70 €	1,63 €	1,57 €	1,50 €

new.



SEDNA_7565

Neceser multiusos de poliéster 600D. Cierre de cremallera con tirador a juego.

22 x 14 x 6 cm 20 300

E(1), N(8), O

-500	+500	+2000	+5000
1,04 €	1,00 €	0,96 €	0,92 €

PARDELA_7513

Neceser de poliéster 600D con cremallera y práctica asa de transporte.

20 x 10 x 8 cm 10 200

F(1), N(8), O

-500	+500	+2000	+5000
1,12 €	1,08 €	1,05 €	1,03 €



BUBO_7547

Neceser de dos compartimentos con cremalleras y cinta de transporte a juego. Realizado en poliéster reciclado RPET 210D.

21 x 13 x 8 cm 20 100

F(1), N(8), O

-500	+500	+2000	+5000
2,68 €	2,58 €	2,48 €	2,38 €

YUBARTA_7514

Neceser de poliéster 600D. Cremallera con tirador a juego.

22 x 14 x 6 cm 10 300

E(1), N(8), O

-500	+500	+2000	+5000
0,940 €	0,910 €	0,860 €	0,820 €



60 05 226 258 02

GRUS_7512

Neceser de poliéster 300D a color en acabado vigoré y PVC transparente, con cremallera y práctica asa de transporte.

23,5 x 18,5 cm 100 200

E(1)

-500	+500	+2000	+5000
1,21 €	1,17 €	1,12 €	1,05 €



01 03 31 60 05 226 40

CARIBU_7511

Neceser de PVC translúcido con cierre hermético.

17 x 13 x 5 cm 50 400

E(1)

-500	+500	+2000	+5000
0,510 €	0,490 €	0,470 €	0,450 €

airport specials

ARNOLD_9935

Neceser de viaje transparente realizado en PVC con cierre hermético. Incluye surtido de prácticos botes ideales para gel, champú y perfume.

19 x 19 cm 1 100

E(1)

-500	+500	+2000	+5000
1,98 €	1,89 €	1,79 €	1,69 €

5 ACCESORIOS





NATURAL CORK



BELLE_1231

Espejo plegable de bolsillo realizado en corcho natural y metal cromado, compuesto por dos espejos, uno normal y otro de aumento. Presentación en caja diseño eco.

2 x Ø6,1 cm 50 200

C(4), L1, W

-500	+500	+2000	+5000
2,50 €	2,40 €	2,30 €	2,20 €



2X



01



60



05



02

GLAZE_1220

Práctico espejo plegable de bolsillo con carcasa de PP translúcido.

0,5 x Ø6 cm 50 500

C(4), W

-500	+500	+2000	+5000
0,280 €	0,270 €	0,260 €	0,244 €

LINER_1223

Espejo doble, uno normal y otro de aumento, con tapas de suave PU y cierre magnético.

0,9 x Ø7 cm 50 300

C(4), L1, W

-500	+500	+2000	+5000
1,89 €	1,82 €	1,75 €	1,67 €

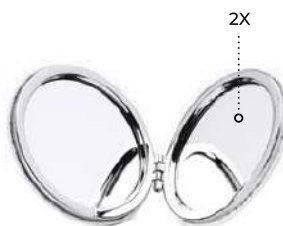

2X



60



05



01

BLUNT_1221

Práctico cepillo plegable de bolsillo con espejo, realizado en PP con diseño sólido.

2,3 x Ø6,6 cm 50 200

C(4)

-500	+500	+2000	+5000
0,690 €	0,650 €	0,630 €	0,580 €



251

49

260

BEISO_ 1225

Bálsamo labial presentado en estuche de diseño tipo esfera, con acabado cromado. Protección SPF15.

Ø3,8 cm

50

500

C(1)

-500	+500	+2000	+5000
1,10 €	1,05 €	1,01 €	0,96 €



BALSAM



WHEAT FIBER

LAPP_ 1230

Bálsamo labial con clásico estuche en forma de barra, realizado en fibra de trigo. Protección SPF15.

7 x Ø1,9 cm

25

500

C(1)

-500	+500	+2000	+5000
0,670 €	0,650 €	0,630 €	0,590 €



01

03

31

60

05

226

40

LISSEN_ 1124

Bálsamo labial con clásico estuche en forma de barra en acabado translúcido. Protección SPF15.

7 x Ø1,9 cm

25

500

C(1)

-500	+500	+2000	+5000
0,500 €	0,490 €	0,480 €	0,470 €





01 60 05 226

**KORA_ 9945**

Cepillo de dientes con cuerpo de PLA. Cerdas blancas de dureza suave. Presentación en caja eco.

18,4 x 1,6 x 1,4 cm

100

600

C(1)

-500	+500	+2000	+5000
0,980 €	0,960 €	0,940 €	0,920 €



KORA



BAMBOO

FRESH_ 9923

Cepillo dental con cuerpo realizado en bambú y cerdas blancas de dureza suave. Libre de aditivos BPA y 100% biodegradable. Presentación en caja diseño de cartón kraft.

17,5 x 1,6 x 1,3 cm

50

400

C(4), L1

-500	+500	+2000	+5000
0,750 €	0,700 €	0,680 €	0,660 €



FRESH

POLE



03 226 60 31 01 242

POLE_ 9924

Cepillo de dientes plegable en PP tamaño viaje. Cerdas de dureza suave a juego.

17,5 x 2,3 x 1,5 cm

50

500

C(1), W

-500	+500	+2000	+5000
0,310 €	0,290 €	0,270 €	0,260 €



CLIVE



03 31 60 05 226

CLIVE_ 9944

Cepillo de dientes con divertido cuerpo de colores y acabado suave, con ventosas en la base para su sujeción.

14,5 x 1,5 x 2,7 cm

50

500

F(1), L1

-500	+500	+2000	+5000
0,320 €	0,300 €	0,280 €	0,260 €

MESLER



03

60

05

226

MESLER_ 9946

Set de cepillo de dientes y reloj de arena. Cepillo de dientes con divertido cuerpo de colores y acabado suave, con ventosas en la base. Reloj de arena de 2 minutos de duración. Presentación en estuche individual con cierre hermético.

19,5 x 7,7 x 2,7 cm

10

200

F(1), L1

-500	+500	+2000	+5000
1,32 €	1,28 €	1,22 €	1,18 €

ANSAR_ 8201

Almohadilla inflable de viaje con suave tacto antelina.

33 x 9 x 25 cm 20 200

F(1)

-500	+500	+2000	+5000
0,960 €	0,940 €	0,890 €	0,860 €



258

55

02



relax & confort

INCLUYE FUNDA



01

02



YLLIER_ 8151

Zapatillas unisex realizadas en cómodo algodón/ poliéster con interior acolchado. Práctica funda de non-woven incluida. Talla única 36-43.

11,5 x 29 x 1,7 cm 10 200

E(1), N(8)

-500	+500	+2000	+5000
1,63 €	1,58 €	1,53 €	1,48 €

BRANTA_ 8200

Máscara de viaje realizada en suave microfibra. Doble elástico de ajuste.

18,5 x 9 cm 100 1000

D(1), N(8)

-500	+500	+2000	+5000
0,330 €	0,320 €	0,300 €	0,280 €





anti**bacterial**
ISO 22196

DROP_ 1222

Pastillero de tres compartimentos, realizado en PP con tratamiento anti-bacterias.

6 x 1,3 x 3,9 cm 100 1000

C(4), W

-500	+500	+2000	+5000
0,260 €	0,250 €	0,240 €	0,230 €



+ anti**bacterial**

ISO 22196

*Material tratado con Iones de Plata que evita la ploriferación de las bacterias.

Organizers



MEDY_ 1227

Práctico pastillero de PP con 2 compartimentos y accesorio cortador.

9,5 x 1,6 x 4,8 cm 100 400

C(4)

-500	+500	+2000	+5000
0,650 €	0,630 €	0,600 €	0,580 €



SEYKU_ 1228

Pelota anti-estrés realizada en PU de color liso.

Ø6,2 cm 20 400

E(1)

-500	+500	+2000	+5000
0,610 €	0,590 €	0,580 €	0,550 €



CITOS_ 1226

Pastillero de PP con tres compartimentos y diseño en acabado translúcido.

6 x 1,3 x 3,9 cm 100 1000

C(4), W

-500	+500	+2000	+5000
0,110 €	0,106 €	0,100 €	0,090 €



BIKU_ 1229

Corazón anti estrés realizado en PU de color liso.

7 x 7 x 4 cm 20 400

E(1)

-500	+500	+2000	+5000
0,740 €	0,710 €	0,690 €	0,660 €

SANITARY & PROTECTION



VARMUS_ 9908

Gel higienizante de manos con 70% de alcohol. Práctico recipiente de 10 ml translúcido y pulverizador tipo spray. Capucha con clip disponible en varios colores.

12,6 x Ø1,6 cm
 50
 500
 B(4)

-500	+500	+2000	+5000
0,680 €	0,660 €	0,630 €	0,600 €

NOBEL_ 9919

Toallita higienizante hidroalcohólica de un solo uso y compostable. 70% de alcohol. Embolsado individual termosellado.

5,7 x 8 cm 100 3000

A(1)

-500	+500	+2000	+5000
0,146 €	0,140 €	0,136 €	0,130 €

70%



BISHOP_ 9906

Gel higienizante de manos con 70% de alcohol. Práctico recipiente de 30 ml con mosquetón.

3,5 x 10 x 2,2 cm 50 200

C(1)

-500	+500	+2000	+5000
1,41 €	1,35 €	1,30 €	1,25 €

30ml

70%



GENZEL_ 9934

Gel higienizante de manos de 30 ml con pulverizador tipo spray.

10,1 x Ø2,7 cm 100 200

C(1), W

-500	+500	+2000	+5000
1,28 €	1,22 €	1,16 €	1,10 €

30ml

70%



GILMAN_ 9907

Gel higienizante de manos. Práctica botella de 50 ml. 70% alcohol.

4,5 x 8,5 x 2,9 cm 50 200

C(1)

-500	+500	+2000	+5000
1,36 €	1,30 €	1,25 €	1,20 €

50ml

70%





antiBacterial
ISO 22196



WHEAT
FIBER

HENRICK_ 9940

Estuche porta-mascarillas realizado en fibra de trigo con tratamiento anti-bacterias. Ideal para proteger y transportar todo tipo de mascarillas.

13 x 13 x 0,7 cm 1 300

D(1)

-500	+500	+2000	+5000
0,720 €	0,700 €	0,680 €	0,620 €



antiBacterial
ISO 22196

WERNER_ 9932

Estuche porta-mascarillas realizado en PP anti-bacterias con doble cierre. Su diseño permite la protección y transporte de todo tipo de mascarillas, además de accesorios higiénicos.

19 x 10,5 x 1,2 cm 1 200

D(1), W

-500	+500	+2000	+5000
0,780 €	0,740 €	0,720 €	0,680 €

+ antiBacterial

ISO 22196

*Material tratado con Iones de Plata que evita la proliferación de las bacterias.



antiBacterial
ISO 22196

AXEL_ 9929

Estuche porta-mascarillas realizado en PP anti-bacterias. Ideal para proteger y transportar todo tipo de mascarillas.

13 x 13 x 1,2 cm 1 300

D(1), W

-500	+500	+2000	+5000
0,680 €	0,660 €	0,640 €	0,580 €

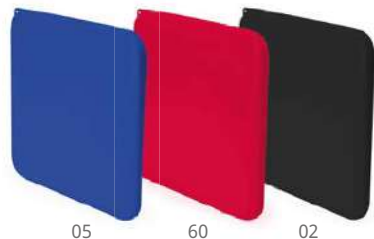



HAWKING_ 8203

Práctica funda porta-mascarillas realizada en flexifle PP troquelado para su fácil plegado. No incluye mascarilla.

9,2 x 5,7 x 0,9 cm 200 2000
B(1)

-500	+500	+2000	+5000
0,140 €	0,130 €	0,125 €	0,120 €



STRICKLAND_ 9939

Funda neceser de PVC multiusos. Cuerpo transparente con cierre a color. Ideal para guardar todo tipo de mascarillas.

20 x 12,5 x 0,25 cm 20 1000
E(1)

-500	+500	+2000	+5000
0,230 €	0,220 €	0,210 €	0,200 €



03



CARIBU_ 7511

Neceser de PVC translúcido con cierre hermético.

17 x 13 x 5 cm 50 400
E(1)

-500	+500	+2000	+5000
0,510 €	0,490 €	0,470 €	0,450 €

5 ACCESORIOS

ARNOLD_ 9935

Neceser de viaje transparente realizado en PVC con cierre hermético. Incluye surtido de prácticos botes ideales para gel, champú y perfume.

19 x 19 cm 1 100
E(1)

-500	+500	+2000	+5000
1,98 €	1,89 €	1,79 €	1,69 €



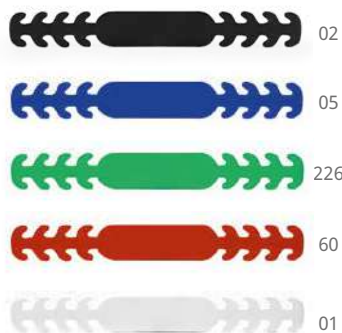

EDISON_ 9920

Sujeta mascarillas de PP en color liso, con cuatro posiciones de ajuste para un perfecto y cómodo uso.

16,5 x 2 x 0,1 cm 100 2000

A(4)

-500	+500	+2000	+5000
0,100 €	0,096 €	0,090 €	0,080 €

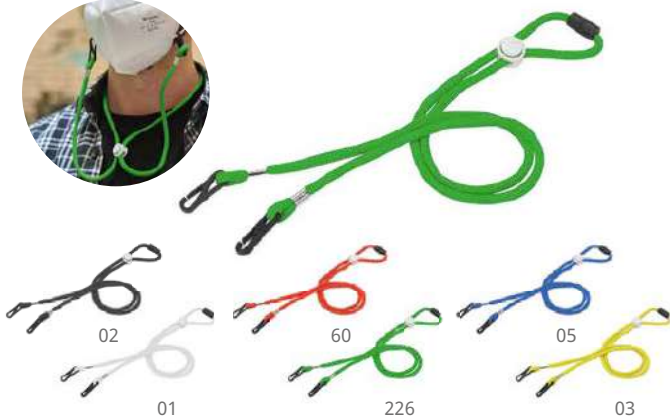

HOLDE_ 7051

Lanyard portamascarillas de cordón y accesorio para ajuste craneal. Válido para todo tipo de mascarillas.

52 x 2 cm 100 1000

D(1)

-500	+500	+2000	+5000
0,360 €	0,340 €	0,320 €	0,300 €



LASSE_ 7056

Lanyard portamascarillas realizado en suave poliéster con cómodos corchetes. Válido para todo tipo de mascarillas.

94 x 1,7 cm 100 2000

F(1), N(8), R

-500	+500	+2000	+5000
0,260 €	0,250 €	0,240 €	0,220 €

2 TAMAÑOS



KEPLER_ 9916

Pantalla facial realizada en cartón laminado blanco y PET. Cierre ajustable con velcro. Acolchado de goma espuma para un cómodo ajuste a la frente. Catálogada como EPI.

31 x 24 cm 5 50

D(2)

-500	+500	+2000	+5000
1,15 €	1,14 €	1,12 €	1,10 €
0,950 €	0,940 €	0,920 €	0,910 €

Kids

Kids



ACOLCHADO INTERIOR



COHN_ 9905

Pantalla facial realizada en resistente material PET. Cinta elástica con cómodo y ergonómico acolchado para su ajuste a la frente incluida. Diseño anti-vaho contra salpicaduras y polvo.

33 x 22 x 0,03 cm 50 200

E(1)

-500	+500	+2000	+5000
0,870 €	0,860 €	0,840 €	0,820 €

+ antibacterial

ISO 22196



SANCAR_ 9938

Toalla absorbente de suave microfibra con tratamiento anti-bacterias. Presentación en funda de PVC.

45 x 30 cm 1 100
G(1), N(8)

-500	+500	+2000	+5000
1,64 €	1,58 €	1,52 €	1,44 €



STODDART_ 9936

Braga multiusos realizada en suave poliéster con tratamiento anti-bacterias. Gramaje de 150 g/m².

26 x 48 cm 10 300
F(1), N(8), R

-500	+500	+2000	+5000
1,52 €	1,46 €	1,40 €	1,32 €



PPE

FRANKLIN_ 9921

Gafas transparentes anti-vaho. Patillas con ventilación lateral, realizadas en ligero policarbonato.

15,5 x 5,7 x 15 cm 10 200
D(4)

-500	+500	+2000	+5000
2,78 €	2,68 €	2,58 €	2,38 €



ABRIDOR



251 05 60 02

ROSS_ 4052

Llavero anti-contacto multifunción de aluminio. Evite tocar cualquier superficie: pulsador, abre puertas, abridor, etc.

6,6 x 2,7 x 0,3 cm 100 1000
D(4), L1

-500	+500	+2000	+5000
0,410 €	0,390 €	0,370 €	0,340 €



01 60 05 02



antibacterial ISO 22196

DALTON_ 4089

Llavero anti-contacto realizado en ABS con tratamiento anti-bacterias.

4 x 7 x 0,4 cm 50 1000
C(4)

-500	+500	+2000	+5000
0,350 €	0,330 €	0,310 €	0,290 €



01 60 05 02



antibacterial
ISO 22196



TOUCH
PEN

FARBER_8022

Bolígrafo higienizante anti-bacterias multifunción, con pulverizador recargable y puntero táctil. 3 ml de capacidad (líquido no incluido). Tinta azul.

16 x Ø1,5 cm 50 1000

B(4)

-500	+500	+2000	+5000
0,720 €	0,680 €	0,660 €	0,620 €

+ antibacterial

ISO 22196

*Material tratado con Iones de Plata que evita la ploriferación de las bacterias.



01 60 40 31 226 05 03



antibacterial
ISO 22196

GRYFIN_8046

Lápiz de madera con tratamiento anti-bacterias y goma disponible en varios colores.

18,6 x Ø0,7 cm 100 2000

A(4)

-500	+500	+2000	+5000
0,106 €	0,094 €	0,090 €	0,086 €

WATSON_8060

ELION_8061



antibacterial
ISO 22196

WATSON_8060

Bloc de notas tamaño A5. Cubiertas de PU con tecnología anti-bacteriana. Marcapáginas y banda elástica. 100 hojas. Norma ISO 22196.

14,9 x 21 x 1,4 cm 25 50

E(4)

-500	+500	+2000	+5000
2,70 €	2,60 €	2,50 €	2,40 €



antibacterial
ISO 22196

ELION_8061

Bloc de notas tamaño A6. Cubiertas de PU con tecnología anti-bacteriana. Marcapáginas y banda elástica. 80 hojas. Norma ISO 22196.

9 x 14 x 1,4 cm 50 100

E(4)

-500	+500	+2000	+5000
2,10 €	2,00 €	1,90 €	1,80 €

+ antibacterial

ISO 22196

*Material tratado con Iones de Plata que evita la ploriferación de las bacterias.



antibacterial
ISO 22196



STARK_ 8040

Bolígrafo con cuerpo de ABS anti-bacterias. Tinta azul. Norma ISO 22196.

13,8 x Ø1 cm 50 1000

A(4)

-500	+500	+2000	+5000
0,140 €	0,130 €	0,125 €	0,120 €



antibacterial
ISO 22196



TOUCH
PEN



HALLERBOS_ 8015

Bolígrafo con cuerpo de ABS anti-bacterias, puntero táctil, clip metálico y carga jumbo de tinta azul. Norma ISO 22196.

13,9 x Ø1 cm 50 1000

A(4)

-500	+500	+2000	+5000
0,390 €	0,380 €	0,360 €	0,350 €



03 31 60 05 226 02



antibacterial
ISO 22196

CARREL_ 8039

Bolígrafo con cuerpo de ABS anti-bacterias y suave agarre de color translúcido. Tinta azul. Norma ISO 22196:2011.

14 x Ø1,3 cm 50 1000

A(4)

-500	+500	+2000	+5000
0,240 €	0,230 €	0,220 €	0,210 €



antibacterial
ISO 22196



NEWTON_ 8038

Bolígrafo con cuerpo de ABS anti-bacterias y tinta azul. Norma ISO 22196:2011.

14 x Ø1,3 cm 50 1000

A(4)

-500	+500	+2000	+5000
0,220 €	0,210 €	0,200 €	0,190 €

It's Christmas!



512



511

MAKA_ 1312

Vela en soporte de madera con diseños navideños (estrella y árbol). Presentación en caja individual.

512: 8,7 x 8,4 x 2,1 cm / 511: 9,4 x 9,4 x 2,1 cm

100 200 E(1), L1

-500	+500	+2000	+5000
1,90 €	1,84 €	1,78 €	1,70 €



512



511

JINGLE_ 1305

Adorno navideño de madera disponible en dos diseños: estrella y árbol. Incluye cinta roja para colgar en el árbol de Navidad.

9,5 x 10 x 0,5 cm

50

400

C(4), L1

Consultar precio



01 251 260 60 02

KIMI_ 1311

Vela aromática en vaso de cristal de colores y fragancias variadas (café, pino, lavanda, vainilla y fresa). Presentada en caja individual.

6,7 x Ø5,6 cm 1 50

F(1), L2

-500	+500	+2000	+5000
1,90 €	1,80 €	1,72 €	1,64 €



PIZARRA

KING_ 1307

Vela aromática con porta-velas pizarra de cerámica. Incluye tiza blanca. Presentación en caja de cartón Kraft.

7,8 x Ø7 cm 1 50

E(1), L2

-500	+500	+2000	+5000
2,50 €	2,40 €	2,32 €	2,02 €



514 512 513

ABEND_ 1302

Adorno navideño de fieltro disponible en tres diseños: copo de nieve, árbol de navidad y reno.

10,1 x 8,3 x 0,3 cm 100 500

C(1)

Consultar precio



CAROL_ 1310

Set de 3 adornos navideños de fieltro: estrella, árbol y reno, para colgar en el árbol de navidad.

10 x 10 cm 100 500

C(1)

Consultar precio

LOTS OF COLORS



01 03 31 60



05 226 02 40

FLAKE_ 1306

Vela aromática en vivos colores presentada a juego con porta-velas metálico. Tapa con ventana transparente.

3 x Ø6,3 cm 50 250

E(1), L1

-500	+500	+2000	+5000
1,28 €	1,22 €	1,17 €	1,11 €



01

31

60

05

226

SANTA_ 1300

Gorro navideño de Papá Noel realizado en suave poliéster. Talla única.

43 x 30 cm 10 200

D(1), N(8)

Consultar precio



viste

tu navidad

**NOEL_ 1301**

Calcetín navideño con tira para colgar, realizado en suave poliéster.

34 x 22 cm 10 200

D(1), N(8)

Consultar precio

**KLAUS_ 1304**

Imán navideño con diseño de Papá Noel. Incluye bloc de notas con 45 hojas lisas y lápiz de madera.

20 x 10 cm 50 200

C(2)

Consultar precio



NICK_ 1309

Gorro de Papá Noel infantil para colorear. Tira frontal con dibujos navideños. 4 ceras de colores incluidas.

41 x 27 cm 50 300

E(1), N(8)

Consultar precio

CERAS INCLUIDAS



CERAS INCLUIDAS



RENO_ 1308

Calcetín con diseño navideño para colorear. Incluye 5 ceras de colores variados. Realizado en non-woven de 80 g/m².

29,5 x 19 cm 1 200

F(1)

Consultar precio



515

516

512

NUSS_ 1303

Lápiz con cuerpo de madera en color blanco y goma de borrar con diseños navideños.

19 x 2,7 cm 50 500

B(4)

Consultar precio

Índice por modelo

MODEL REF. PAG.

A			
ABEND	1302	341	
ADAL	7544	56,192	
ADARE	7175	38,179	
AKALA	0100	271	
AKEBIA	4008	210	
ALANI	8073	30,140	
ALAX	3030	11,98	
ALBA	8050	138	
ALBERO	3110	290	
ALDER	8079	23,177	
ALESSO	3210	15,82	
ALETA	7531	302	
ALFE	4037	236	
ALGOR	4113	66,240	
ALKE	4034	227	
ALOE	4044	232	
ALONDRÁ	7524	160	
ALPINIA	4042	223	
AMAZONIA	8001	132	
ANFI	8057	134	
ANGUS	4116	68,240	
ANON	4015	209	
ANSAR	8201	173,300	
ANTIX	3055	71,256	
AOKI	3300	90	
ARAL	8037	26,128	
ARASHI	8048	26,128	
ARAYA	8023	130,267	
ARCE	7538	49,157	
ARCO	8054	141	
ARDAK	8091	139	
ARDEA	7552	40,152	
ARDENES	8013	127	
ARETA	3097	281,294	
ARIEL	8103	309	
ARIES	3006	107	
ARMIN	3204	84	
ARNOLD	9935	191,325,335	
AROLA	9136	37,246	
ARTUR	8044	27,122	
ASTRO	3019	18,106	
ATHLETIC	4045	228,276	
AXEL	9929	334	
AZOR	7529	183,254	
B			
BAGUETTE	7519	41,151	
BAIKAL	5603	202	
BALAX	4122	220	
BAOBAB	4049	228,276	
BARNET	7166	163	
BASH	7070	292	
BASICA	7000	318	
BATUR	0102	271	
BAUME	8005	126	
BAY	7103	316	
BEISO	1225	327	
BELLE	1231	74,326	
BELOC	7015	285	
BELVER	4030	165,216	
BENDER	3350	105	
BERING	5622	197	
BERNA	7156	32,146	
BERRY	4012	212	
BIKING	4047	235	
BIKU	1229	261,331	
BIOTAL	4096	265	
BISHOP	9906	333	
BISMAR	7608	54,164	
BLUES	3026	19,87	
BLUNT	1221	326	
BOBIN	6999	299	
BODEN	7125	163	
BOINA	4039	226,276	
BONCER	4110	71,256	
BOPP	3013	107,172	
BORA	0103	269	
BORAN	4115	69,242	
BOREAL	8000	132	
BORNEO	8014	126	
BOSCO	8063	134	
BRANDON	5624	77,196	
BRANTA	8200	173,300	
BRENA	4069	215	
BRESCIA	7165	178	
BRILL	0107	267	
BRISA	8100	309	
BRISCA	1016	252	
BUBO	7547	55,190,324	
BUDAN	4054	70,257	
BURAK	3309	13,89	
BUSTAN	4062	62,213	

C			
CALAO	7151	182	
CALES	8072	29,137	
CALESA	3111	290	
CALISTO	7050	318	
CALON	1022	300	
CALPE	7101	316	
CALVIN	3202	85	
CAMU	4040	237,276	
CANAIMA	8004	126	
CANARY	7121	184	
CANES	3007	107	
CARIBU	7511	191,325,335	
CARNIVAL	3101	288	
CAROL	1310	341	
CARREL	8039	119,339	
CELEB	3103	289	
CELERY	4048	225,276	
CELSIUS	3016	14,97	
CENIX	1023	301	
CETUS	3008	106	
CHAKRA	7102	315	
CHALA	4087	66,244	
CHARRAN	7517	171	
CHITO	4058	233	
CHUCAO	7146	166	
CIRO	8101	308	
CITOS	1226	331	
CLIVE	9944	329	
CLOUD	8110	275,307	
COAST	7543	159	
COCO	4081	60,214	
COHN	9905	336	
COLIBRI	7510	174	
COLINA	7559	129	
COLINS	4111	67,243	
COLMER	4117	61,216	
COLOMA	8017	125	
COLUMBA	7120	186	
COLUMBIA	1017	270	
COMET	7013	287	
COMPER	8043	27,117	
COMTE	4102	65,240	
CONDOR	7153	177	
CONVI	8076	118	
COPO	4059	222,277	
CORAL	8051	138	
CORE	3024	16,100	
CORK	7119	316	
CORVET	8002	131	
COX	3200	85	
CREST	7506	161	
CROSSFITTER	9001	313	
CRUX	3009	106	
CUANCA	7150	181	
CUSTIK	3310	8,83	
CYLON	4187	113	
D			
DAIKON	4103	61,215	
DALIA	4107	214	
DALTON	4089	259,337	
DAMASCO	4014	208,278	
DAMPER	5600	202	
DANERIS	5625	196	
DANICA	8053	30,135	
DAX	8102	307	
DEAN	8065	143	
DELPHIS	7536	34,189	
DENIA	7096	298	
DEVON	4114	68,241	
DILBAR	3356	8,102	
DIMAS	8062	134	
DISCOVERY	2100	92	
DODO	7138	174	
DOEL	7537	189,323	
DOMIS	1013	253	
DONET	7126	161	
DORMITUR	8012	124	
DRACO	3401	95	
DROIDE	3354	17,104	
DROP	1222	331	
DUCASSE	9129	248	
DUKE	7171	169	
DUNE	7525	41,151	
DURIAN	4027	230	
DUSK	7060	288	
E			
ECOHOST	7055	73,293	
EDAM	4101	242	
EDDO	4041	233	
EDEN	8104	306	
EDISON	9920	336	
EIDER	8202	301	

ELANIO			
ELON	7528	183	
ELSON	8061	138,338	
ELVIS	3311	9,83	
EMON	7049	281,295	
EMON	7097	315	
ENOKI	9137	247	
ERIS	7019	319	
ESTELA	8070	29,139	
F			
FALCO	7115	187	
FALCON	3105	101	
FANCY	4026	220	
FARBER	8022	119,338	
FARGO	5611	200,280	
FENGI	4035	58,218	
FENIX	8020	142	
FEROE	1003	300	
FERRY	3305	89	
FESTERO	9003	290	
FETE	3102	291	
FINGER	4021	217	
FLAG	4080	258,289	
FLAKE	1306	250,341	
FLASH	0110	267	
FLAY	7164	42,153	
FLINT	8066	143	
FLUME	3303	91	
FOCHA	7523	160	
FORNAX	3400	95	
FRANKLIN	9921	337	
FRESH	9923	74,328	
FROSTY	6998	197	
FUNK	3307	88	
G			
GALA	8082	28,136	
GALAXY	7063	72,287	
GALVY	1014	253	
GAMMA	3027	17,100	
GARNAC	4118	245	
GARO	8085	31,135	
GARRIX	3201	85	
GARZA	7518	172	
GAVIA	7099	43,154	
GAVILAN	7509	182	
GENZEL	9934	333	
GILDON	8080	21,120	
GILMAN	9907	333	
GLAZE	1220	326	
GLEN	8067	143	
GORBEA	8028	119	
GORDON	3014	107,172	
GOSTO	4064	217	
GRAJA	7604	305	
GRAVITY	3022	16,99	
GRETA	7167	32,146	
GROVE	8029	23,117	
GRULLA	7605	165	
GRUS	7512	191,325	
GRYFIN	8046	131,338	
GUAYA	4082	209	
GUEST	7054	292	
H			
HAL	3353	103	
HALE	0109	267	
HALLERBOS	8015	127,339	
HALLEY	7062	286	
HAMELIN	7114	180,274	
HANA	8032	25,123	
HARDWELL	3207	15,82	
HARUL	5609	200,280	
HAWKING	8203	335	
HAYA	7539	49,157	
HAYEDO	8030	25,127	
HELDENS	3209	12,80	
HENRICK	9940	344	
HERA	8068	143	
HIBIS	4053	70,257	
HILL	7601	39,150	
HILLOCK	7520	39,150	
HINDRES	8045	116	
HOLDE	7051	336	
HORUS	8059	143	
HOST	7053	292	
HYDRA	3054	110	
I			
ICARUS	3029	14,96	
INNIS	8056	134	
IRATI	8011	124	
IRIS	8071	29,137	
J			
JACK	4010	206	
JADE	8027	24,122	
JAMBOREE	3106	288	

JAMIE			
JAVARI	9133	249	
JERRY	8016	125	
JINGLE	3052	108	
JINGLE	1305	340	
JOJGER	7117	184	
JONES	7018	285	
K			
KAFFIR	4060	208,278	
KAGU	7155	181	
KALAY	8150	299	
KALE	4105	64,222	
KALMAR	7500	53,170	
KAMUT	8035	24,116	
KANCHAN	8024	130,266	
KASPER	3050	109	
KASTER	4098	237,277	
KELLER	9130	249	
KELSEY	7057	317	
KELVIN	3004	14,97	
KEMER	7600	51,304	
KENDAL	4124	281,295	
KENSAL	7168	33,147	
KEPLER	9916	336	
KETU	3020	111	
KHASI	5610	76,199	
KIMI	1311	250,341	
KINATA	4032	59,219	
KING	1307	251,341	
KINI	0101	271	
KINKAN	4038	232	
KINTO	4121	303	
KIOTO	8036	20,121	
KIWAU	4083	209	
KLAUS	1304	342	
KNOLL	7521	149	
KOPER	7148	42,155	
KORA	9945	74,328	
KORAT	1021	272	
KORLAN	4066	61,215	
KRAVIZ	3206	15,81	
KRUMER	8090	126	
KUMAT	4036	235	
KUMBO	4002	206,279	
KURA	3302	91	
L			
LADAS	4068	216	
LACER	4072	260	
LAKE	7503	163	
LAMBERT	5621	196	
LANCER	3002	110	
LANDER	3003	103	
LANKA	8205	301	
LANZA	1020	273	
LAPP	1230	75,327	
LARUS	7550	55,180	
LASSE	7056	336	
LAURISILVA	8026	24,122	
LEAF	7553	40,152	
LEGRAND	3150	86	
LEIS	0111	254	
LEVY	7014	72,284	
LIANDE	8042	23,117	
LIBE	7516	171	
LIEN	8074	30,141	
LIKA	8025	24,118	
LILIAN	8047	255	
LIMA	4000	207,278	
LIMOSA	7545	75,193	
LINER	1223	326	
LISSEN	1124	327	
LIZANA	8064	132	
LOCK	0108	264	
LONGAN	4031	229	
LORA	7515	171	
LULO	4025	230	
LYRA	3010	17,99,256	
LYSE	5607	201	
M			
MABEL	8089	132	
MACK	1007	269	
MAKA	1312	251,340	
MALBEC	4112	245	

Índice alfabético

ARTÍCULO	PAG.		
A		Cepillos de dientes	74, 328, 329
Abanicos	290	Ceras de colores	132
Abridores	66, 67, 243	Chancias	299
Adaptadores de corriente	107, 172	Cinta deportiva	313
Adornos de Navidad	340, 341	Cinta para sombrero	286
Agendas	143	Collar de mascotas	272
Ajustador mascarillas	336	Combas	314
Alfombra cargador	11, 98	Cubo	303
Alfombra de ratón	108, 109, 142, 281	Cutters	264
Almohadillas de viaje	173, 330	D	
Altavoces inalámbricos	8, 9, 10, 12, 13, 15, 19, 80, 81, 82, 83, 84, 85	Delantales	35, 37, 183, 246, 248, 249
Altavoz cargador	12, 80, 81, 85	Dispensador de bolsas	272
Anti estrés	261, 331	E	
Aplaudidores	288, 289	Espejos	74, 326
Auriculares	90	Estación meteorológica	14, 97
Auriculares inalámbricos	9, 13, 86, 87, 88, 89, 90, 91	Esterilla de yoga	315
B		Estuches	27, 129, 193
Balón	300	F	
Bálsamos	75, 327	Fiambreras	60, 61, 62, 213, 214, 215
Banderines	289	Flexómetros	264
Báscula digital	69, 241	Frisbee	300
Bastoms	288	Funda de gafas	275, 307
Bastones	312	Funda para jamón	162
Batería Externa Inalámbrica	103	Funda porta mascarillas	234, 235
Baterías Externas	8, 17, 18, 102, 103, 104, 105	G	
Bidones	58, 60, 63, 64, 219, 220, 221, 222, 223, 226, 227, 228, 229, 231, 232, 233, 234, 235, 236, 237	Gafas de seguridad	337
Bidones de cristal	60, 236, 237	Gafas de sol	306, 307, 308, 309
Bidones para sublimación	222, 226, 227, 237, 276, 277	Geles hidroalcológicos	332, 333
Bidones termo	220, 221	Gorras	317, 318, 319
Bloc de notas	28, 29, 31, 135, 137, 138, 139	Gorro	197, 198
Bloc de notas Anti bacterias	138, 338	Gorro de Navidad	342, 343
Bloc de notas papel semillas	31, 135	Guante táctil	197
Bolígrafo linterna	130, 267	I	
Bolígrafo marcador	26, 128	Identificadores	292
Bolígrafo multiherramienta	130, 266	Imán porta notas	342
Bolígrafo spray	119, 338	J	
Bolígrafos	20, 21, 22, 23, 24, 25, 26, 27, 116, 117, 118, 119, 120, 121, 122, 123, 124, 125, 126, 127, 128	Juegos de habilidad	252, 253, 254
Bolígrafos Anti bacterias	116, 119, 127, 339	L	
Bolígrafos con puntero	20, 21, 24, 118, 125, 126	Landyards	73, 292, 293
Bolsa mochila	36, 178	Lanyards Portamascarillas	236
Bolsas	32, 33, 36, 39, 40, 41, 42, 43, 44, 45, 50, 51, 56, 57, 146, 147, 148, 149, 150, 151, 152, 153, 154, 155, 158, 159, 160, 161, 162, 163, 275	Lanyards Sublimación	281, 295
Bolsas algodón	32, 33, 36, 39, 40, 41, 146, 147, 148, 149, 150, 151	Lápices	131, 266, 338
Bolsas de papel	48, 49, 156, 157	Lápices de colores	132
Bolsas de yute	42, 43, 44, 45, 153, 155	Lápiz de carpintero	131, 266
Bolsas estancas	302	Lápiz de Navidad	343
Bolsas para deporte	184, 185	Libreta papel semillas	31, 135
Bolsas para sublimación	161, 275	Libretas	28, 30, 31, 135, 137, 140, 141
Bolsas plegables	160	Linternas	267
Bolsas RPET	56, 57, 158	Llavero Anti contacto	259, 337
Bowl plegable	273	Llavero flexómetro	261
Braga Corro	198	Llavero sublimación	281, 295
Bragas polares	198	Llaveros	70, 71, 256, 257, 258, 259, 260, 261, 289
C		Lupa cuentahilos	266
Calcetines de Navidad	342, 343	M	
Calendarios	143	Maceta	250
Calendarios perpetuos	142	Manopla	35, 247, 281
Cámara deportiva	92	Manopla sublimación	281
Cargador soporte	99, 110	Mantas	77, 196, 197
Cargador USB de coche	110	Máscara facial	173, 330
Cargadores inalámbricos	8, 11, 12, 16, 17, 19, 98, 99, 100, 101, 102, 103	Memorias USB	113
Cargadores Llavero 3 en 1	15, 106, 107	Mini Libreta	141
Catería Externa Solar	17	Mochila nevera	305
Cenicero de bolsillo	301	Mochila RPET	166, 167
Cepillo con espejo	326	Mochilas	52, 53, 55, 166, 167, 168, 169, 174, 175, 176, 177, 178, 179, 180, 181, 182, 183, 184, 185, 186, 187, 274
		Mochilas algodón	34, 36, 38, 178, 179
		Monederos	56, 75, 192, 193
		Multiherramientas	265
		Muñequera	313
		N	
		Navajas multiusos	265
		Neceseres	34, 37, 46, 47, 55, 188, 189, 190, 191, 322, 323, 324, 325, 335
		Neveras	50, 51, 54, 55, 164, 165, 304, 305
		O	
		Organizador cargador	16, 100
		Organizador de maletero	268
		P	
		Pajitas	216, 217
		Palas de playa	300
		Pañoletas	290
		Paraguas	200, 201, 280
		Paraguas plegables	76, 199, 280
		Paraguas RPET	19
		parasoles	269, 270, 271
		pastilleros	331
		Pelota	273
		Pizarra magnética	255
		Ponchos impermeables	76, 202, 203
		Porta notas adhesivas	134
		Portadocumentos	53, 170, 171, 172
		Portalápices	10, 98
		Portamascarillas	334, 335
		Portatodo	301
		Posavasos	66, 240, 244
		Puerto USB	18, 109
		Pulseras	73, 281, 291
		Pulseras sublimación	281, 294
		Puzzle	254
		R	
		Rascador de hielo	268
		Ratones inalámbricos	108, 109
		Reloj cargador	14, 96
		Relojes inteligentes	93, 94, 95
		Riñoneras	192
		Rollers	125
		S	
		Sacacorchos	245
		Set adornos de Navidad	341
		Set Bandas Elásticas	315
		Set bolsas reciclaje	159
		Set cepillo de dientes	329
		Set de cubiertos	61, 165, 216
		Set de herramientas	268
		Set de juegos	252, 253
		Set de vino	65, 244
		Set Escritura	20, 22, 28, 132
		Set infantil de pintar	22, 133, 255
		Set Pajita / Tenedor	217
		Set para quesos	65, 240, 242
		Silbato	288
		Sombreros	72, 284, 285, 286, 287, 288
		Sombrilla de playa	299
		Soporte para Smartphone	12, 16, 17, 71, 99, 110, 111, 256
		T	
		Tabla de cortar	68, 69, 240, 241, 242
		Tangram	254
		Tapa webcam	109
		Tazas	58, 60, 62, 206, 207, 208, 209, 210, 211, 212, 213, 214, 218, 278, 279
		Tazas para sublimación	206, 207, 208, 278, 279
		Termos	58, 59, 218, 219, 224, 225, 276
		Toalla Pareo	298
		Toallas	298, 316, 337
		Toallira higienizante	333
		U	
		USB HUB	18, 109
		V	
		Vasos	59, 62, 212, 213, 217, 219, 229, 230
		Velas	250, 251, 340, 341
		Visera	317
		Y	
		Yoyó	254
		Z	
		Zapatillas	173, 330

Códigos de color

CÓDIGO

COLOR









01	Blanco	57	Granate	124	Verde Senda	256	Granate Vigoré	989	Piña
011	Blanco Perla	116	Rojo Vino	56	Verde Botella	252	Rosetón Vigoré	990	Kiwi
58	Gris	48	Rosa Claro	20	Verde Kelly	253	Morado Vigoré	991	Baloncesto
251	Plata	34	Rosa Chicle	216	Verde Tropical	246	Turquesa Vigoré	992	Fútbol
260	Oro	72	Frambuesa	271	Verde Sage	248	Royal Vigoré	993	Tenis
281	Oro Rosa	78	Rosetón	17	Verde Lab	255	Azul Dénim Vigoré	995	Cebra
23	Plomo	40	Fucsia	13	Verde Kaki	247	Azul Marino Vigoré	996	Pollo
231	Ébano	230	Orquídea	15	Verde Militar	980	Verde Menta Vigoré	997	Jirafa
59	Gris Oscuro	63	Morado	38	Verde Militar Oscuro	257	Verde Botella Vigoré	998	Pez
46	Plomo Oscuro	71	Púrpura	118	Lima Limón	153	Verde Militar Vigoré	999	Bambú
02	Negro	126	Azul Lavado	69	Verde Mantis	693	Verde Mantis Vigoré	511	Estrella
29	Crudo	10	Celeste	28	Pistacho	250	Lima Vigoré	512	Árbol
165	Nude	12	Turquesa	225	Lima	135	Verde Helecho Vigoré	513	Reno
229	Angora	43	Azul Profundo	235	Lima Punch	249	Amarillo Flúor Vigoré	514	Copo
07	Arena	100	Azul Océano	114	Verde Oasis	244	Coral Flúor Vigoré	515	Noel
85	Camel	05	Royal	24	Verde Irish	222	Verde Flúor	516	Snowman
219	Arena Oscura	99	Azul Eléctrico	83	Verde Grass	221	Amarillo Flúor	981	Rectangular
67	Nogal	65	Azulina	226	Verde Helecho	223	Naranja Flúor	982	Round
87	Chocolate	86	Azul Dénim	450	Marrón	228	Rosa Flúor	983	Oval
36	Amarillo Cáñamo	43	Azul Niágara	013	Blanco Vigoré	125	Rosa lady Flúor	88	Wood
03	Amarillo	44	Azul Lab	259	Gris Claro Vigoré	234	Coral flúor	157	Spain
96	Amarillo Golden	55	Azul Marino	237	Ébano Vigoré	84	Fresa	158	France
30	Mostaza	98	Verde Menta	243	Negro Vigoré	985	Limón	161	Italy
31	Naranja	041	Verde Marea	39	Mostaza Vigoré	984	Sandia	162	Portugal
311	Naranja Bemellón	236	Aguamarina	310	Naranja Vigoré	986	Manzaba		
60	Rojo	45	Azul Luz de Luna	245	Rojo Vigoré	987	Tomate		
64	Borgoña	217	Verde Jungla	238	Borgoña Vigoré	988	Uva		

Iconografía

-  CAJA
-  PACK
-  MEDIDAS
-  TÉCNICA DE MARCAJE
-  RESISTENTE AL AGUA
-  IMPERMEABLE
-  RESISTENTE AL VIENTO
-  TRANSPIRABLE
-  TEJIDO TÉCNICO
-  ETIQUETA REMOVIBLE
-  Kids TALLA DE NIÑO
-  ALIMENTACIÓN

-  TECNOLOGÍA BLUETOOTH
-  FUNCIÓN ALTAVOZ
-  CARGA INALÁMBRICA
-  RADIO INTEGRADA
-  LECTOR TARJETA MICRO SD
-  CONEXIÓN LINE IN
-  REPRODUCTOR USB
-  MANOS LIBRE

-  CONTADOR DE PULSACIONES
-  CONTADOR DE CALORIAS
-  CONTADOR DE PASOS
-  CONTROL DEL SUEÑO
-  CRONÓMETRO
-  DISPONE DE APLICACIÓN
-  NOTIFICACIONES DE APLICACIONES
-  TRANSMISIÓN DE DATOS

-  RESISTENTE AL AGUA
-  BAMBÚ
-  FIBRA DE TRIGO
-  USB
-  TIPO C
-  MICRO USB
-  LIGHTNING
-  LIGHT

-  RESISTENTE AL VIENTO
-  CEMENTO
-  CORCHO NATURAL
-  PLA
-  DIÁMETRO PARAGUAS
-  FECHA Y HORA
-  HORA

Técnicas de marcaje



Código de marcaje	Técnica
A - K	Tampografía - Serigrafía
M	Cuatricomía
N	Transfer serigráfico
O	Transfer digital
Q	Sublimación tazas

R	Sublimación
T	Termo grabado
U	Termo grabado con cinta color
W	Impresión digital
P	Bordado
L	Láser

Nos reservamos el derecho a modificar sin notificación previa los códigos de impresión y/o número de colores publicados en este catálogo.